

MecFlow. The future of supply systems

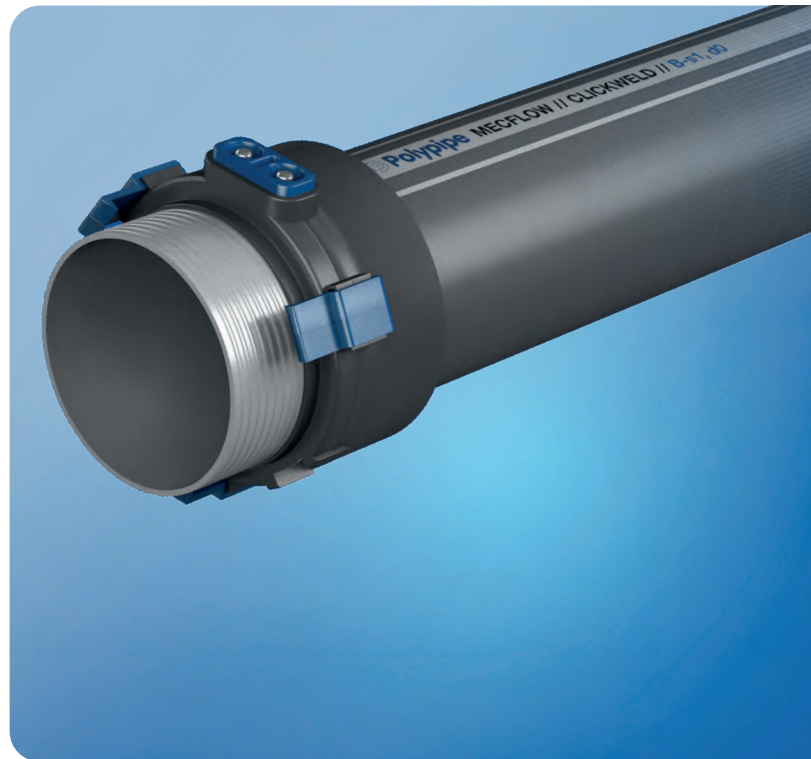

Design, specification and installation guide

1. Contents

SECTION 1	Welcome to Polypipe	Page
	Welcome to Polypipe	4 – 5
SECTION 2	Introducing MecFlow	
	Introducing MecFlow	6 – 7
	Features and Benefits	8 – 9
	Applications	10 – 11
SECTION 3	Polypipe Advantage and MecFlow	
	Polypipe Advantage and MecFlow	12
	Support	13
	Enjoy the Advantages	14 – 15
SECTION 4	Chemical Resistance	
	Chemical Resistance	16
	Chemical Resistance Tables	17 – 25
SECTION 5	System Sizing	
	System Sizing	26
	Diameter Equivalence MecFlow and Copper Pipes	27
	Diameter Equivalence MecFlow and Steel Pipes	28 – 29
	Co-efficient of Loss by Product Type	30 – 31
	MecFlow Temperature and Pressure Ratings	32
	MecFlow Pressure Loss	33 – 43
SECTION 6	Joining Methods	
	Joining Methods	44
	Thermo-form Welding	44
	Joining Preparation	45 – 46
	Polypipe Advantage Off-site Manufacturing	47
	Socket Fusion Welding	48 – 51
	Butt Fusion Welding	52 – 57
	Electrofusion Welding	58 – 62
	Mechanical Joining	63
SECTION 7	Installation	
	Installation	64
	System Bracketing	64 – 65
	Thermal Movement	66 – 75
SECTION 8	System Commissioning & Maintenance	
	System Commissioning & Maintenance	76 – 79
SECTION 9	Approvals	
	Quality Management System and Assurance	80 – 81
	Manufacturing Standards	82 – 83
SECTION 10	Technical Specification	
	Technical Specification	84
	System Description	84 – 85
SECTION 11	Support	
	Support	86
	Polypipe Building Services	87



1. Welcome to Polypipe

We are a company proud to be a part of the construction industry. It's grown with us, and us with it. We understand the challenges today's projects face both from an economic and sustainability basis – having to prove best value, whole life costs and delivery within the project timeframe.

Because we work within our specific market sectors, with the many different types of people making up the project delivery team, we understand all the key touchpoints of a project, and we can provide design and product support right from the start through to completion.

SUSTAINABLE WATER AND CLIMATE MANAGEMENT

At Polypipe, we're proud of our British heritage and one we continue to build on, helping our customers in all areas of construction to deliver the best possible project results, from water management to climate management..

For example, continued development of our Underfloor Heating Smart Controls to deliver more affordable, controllable energy. Drainage stacks that are developed and manufactured off-site and delivered to site complete and ready to install; saving on cost, labour, installation time and waste. Sustainable methods in which to store and reuse rainwater, using recycled materials where appropriate, to help cool inner cities whilst reducing the strain on potable water and sewers. And provide low-energy filtered clean air and heat recovery systems within buildings for a healthier, more comfortable living experience.

For more information on all our climate and water management solutions visit polypipe.com



SECTOR-FOCUSED TO UNDERSTAND YOUR VISION

Through experience and expertise, we have a detailed understanding of the complexity of our commercial customers' projects, the challenges that can arise and the applications in which our systems are used. Therefore, working within these environments and understanding the regulations required, we are able to deliver water management and climate management solutions that make a truly positive difference.

We know that it takes a team of different disciplines, from Client to Contractors, and those in between, to deliver it. And working closely with external influencers, we are able to establish and deliver the best results from the ground up – and down again.

POLYPIPE BUILDING SERVICES

From schools, hospitals and tall buildings to shopping centres and commercial and industrial developments, Polypipe Building Services brings you more.

More innovation, more expertise and more support, developing and delivering engineered drainage and water supply systems and services. From our trusted Terrain drainage solutions to our innovative fabrication service, Polypipe Advantage, we always look to advance new products and services that optimise on-site quality and productivity, so we can achieve more, together.

Created and developed to support you and your projects, Polypipe Building Services' innovative systems and solutions make it easier to create safe and sustainable commercial buildings.

Dedication towards delivering quality, sustainable products and services means a great deal to us, our supply chain and our customers – and has been recognised by the BSI with ISO 14001, ISO 9001, ISO 45001 and BES 6001 accreditations.

2. Introducing MecFlow



MecFlow is a simple, reliable alternative to traditional supply systems, taking an already tried and tested material, and developing it to give you so much more. 'More' in terms of a multi-layer, WRAS approved, PP-RCT system. 'More' for its strength and durability. And 'more' in achieving a fire classification rating of B-s1, d0*; making it ideal for multi-occupancy and tall building projects.

More, still, MecFlow showcases engineered CLICKWELD technology, enabling pre-assembly installation before final electrofusion welding without the need for external clamping, making for a faster weld.



Polypipe Advantage is integral to what makes MecFlow so unique.

The component parts of your system, specific to your design, will be manufactured off-site through the Polypipe Advantage service and delivered to you as a Kit.

See page 12 for more information.

*Fire classification rating according to EN13501, MecFlow to be installed in accordance with building regulations. Where required we recommend MecFlow is installed with Polypipe Firetrap sleeves.

2. Features and benefits

MECFLOW BENEFITS YOUR PROJECT MORE

With its multi-layer PP-RCT material formulation and unique CLICKWELD installation capabilities, MecFlow delivers the features and benefits you need to get the job done quick, easy and without compromising on quality.

MATERIAL



LOW NOISE TRANSMISSION

Due to its material properties the MecFlow system provides high resistance to the propagation of noise from water flowing at high velocities within its internal bore.



ANTI-MICROBIAL PROTECTION

The MecFlow system is manufactured using a patented material additive within the internal bore surface that prevents pathogens attaching and developing into bacterial colonies.



CHEMICAL RESISTANCE

MecFlow has excellent chemical resistance due to its high molecular weight and non-polar polymer structure. It is resistant to fluids from pH1 to pH14.



LESS ON-SITE STORAGE

Through the Polypipe Advantage service, MecFlow is delivered in Kits exactly when you need it, reducing the need for long term on-site storage.



ABRASION RESISTANCE

The smooth and mechanically robust bore of the MecFlow system protects against material erosion due to the flow of aggressive fluids over long periods of time.



UV RESISTANCE

The MecFlow material formulation protects against oxidation by direct exposure to UV radiation from sunlight.

INSTALLATION



CLICKWELD TECHNOLOGY

The unique CLICKWELD technology means no clamps are required for welding, the clips ensure a consistent weld and allow for pre-assembly before electrofusion welding for a secure, long-lasting joint.



INCREASED MECHANICAL STRENGTH

Due to the addition of micro-fibres to the material formulation, the MecFlow system has improved temperature and pressure characteristics giving it excellent mechanical strength over a range of fluid temperatures.



MAXIMISED WATER QUALITY

The system's smooth bore and high chemical resistance maintains the quality of water supplied over the lifecycle of the MecFlow system.



FAST INSTALLATION

With both the CLICKWELD technology and the MecFlow system being delivered in Kits, faster installation is achieved vs traditional installation methods.



LESS ON-SITE WASTE

Through the Polypipe Advantage service, MecFlow is delivered in Kits so you get exactly what you need, reducing packing and on-site waste. What's more Polypipe will recycle any offcuts or end caps at the end of your project.



LOWER LABOUR COSTS

With the system's fast installation method and less labour required for installation, projects benefit from a reduction in labour costs.

2. Applications

MECFLOW BENEFITS MORE OF YOUR PROJECTS

- Boosted Cold Water (BCWS)
- Chilled Water (CHWS)
- Low Temperature Hot Water (LTHW)
- Domestic Hot Water (DHW)*
- In a range of joint fittings; Tee piece, Elbow piece, Straight piece and Manifold to configure the perfect system

* Not suitable for recirc applications

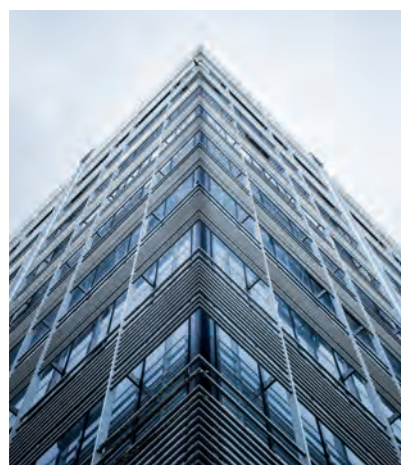

DESIGN SUPPORT

To ensure your system meets the requirements of your chosen application, the Polypipe Advantage team can work with you, providing assistance and design support to deliver results that matter.



3. Polypipe Advantage and MecFlow



Polypipe Advantage brings your project together

Polypipe Advantage, from Polypipe Building Services, offers an end-to-end solution for the UK commercial market. It supports you and helps design your perfect water supply system, before creating it within our state-of-the-art fabrication and testing facility under factory-controlled conditions. The component parts of your system, specific to your design, will be manufactured off-site and delivered to you as a Kit.



Support

From design and planning to ordering, delivery, technical support and customer service, Polypipe Advantage provides everything you need to plan your project.

You'll have access to our team of dedicated Project Managers, who will work with you to create an exact delivery schedule. This means your MecFlow Kit reaches site exactly at the point you need it, ensuring that it can be installed straight away, with no need for storage. Simply remove the components and follow the instructions.



ASSESSMENT AND ESTIMATION

Every good project begins with a thorough plan. The Polypipe Advantage team is on hand from the outset, to appraise your enquiry to identify any unique project requirements before creating a draft estimate.

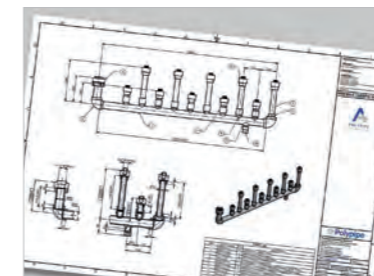

DESIGN

The Polypipe Advantage team will produce detailed CAD drawings for approval, all designs are compliant to as-drawn dimensions. This means you save vital planning time and won't have to compromise with inappropriate or over-engineered solutions.



ORDERING AND FABRICATION

Once you've reviewed the design and it's finalised, our state-of-the-art fabrication and testing facility will create your system under factory-controlled conditions, ensuring only the highest quality and peace of mind for first-fix testing. All components are tested to 1.5x the site-specified design pressure and follow the method laid out in Section 8, System Commissioning.



DISPATCH AND DELIVERY

We know that time and scheduling are critical for any project, so we ensure your system is delivered how and when you need it – while keeping you updated along the way. Our team of logistics experts work with your project timelines to ensure each element of your unique system arrives to site as scheduled, removing the need for on-site storage; leaving you to focus on installation.



MERCHANT INTEGRATION

You can purchase fabricated systems from our approved Merchants, who will be happy to take your order, arrange the details with the Polypipe Advantage team – and deliver it in time for your next job.



SUSTAINABILITY

While our streamlined approach to fabrication can make your projects more efficient, it also offers wide-reaching sustainability benefits. Because we deliver precisely what you need, and nothing more, there are no spare parts or unnecessary extras to dispose of. We've invested heavily into sophisticated technology, ensuring our pipes are of the highest quality and are 100% recyclable at the end of life.

Enjoy the advantages

Partnering with Polypipe Advantage delivers more than innovative products and systems for your project – it also delivers solutions for those construction challenges.

We'll appraise your enquiry and provide you with an estimate. You'll also receive detailed CAD drawings for approval, ensuring all designs are compliant. Your new MecFlow Kit is manufactured off-site and delivered to site ready to install, removing the need for on-site storage, reducing waste, reducing labour, and enabling quick and easy installation, with the potential to save you up to 75% of installation time.

Polypipe Advantage makes everything simple.



MECFLOW PRODUCT CODES

Each MecFlow product will be identified with a prefix and suffix coding system, making it easy to locate the correct components for installation.

The code's prefix denotes the product family (MecFlow) and application joined to the Polypipe project reference number.

Example

- MFB – MecFlow Boosted Cold Water
- MFL – MecFlow LTHW
- MFD – MecFlow Domestic Hot Water
- MFC – MecFlow Chilled Water

The code for Mecflow Boosted Cold Water on project reference 123456 would be: MFB123456. This code will

also be used to identify each fabricated part on the design drawing, for simple cross-referencing prior to installation. In any project, and especially those of a larger scale, a number of fabricated parts will be called off simultaneously as the building project evolves. To avoid the requirement to process numerous codes, we have designed the coding process to be set up as a zone call off.

For example, if there are 100 fabricated parts designed for a project – where the order call off requires five different deliveries for equipment – the order can be processed using a combination of a zone code (1-100) and the project reference number 123456:

- Zone 1 - 123456
- Zone 2 - 123456
- Zone 3 - 123456
- Zone 4 - 123456
- Zone 5 - 123456

Each delivery could then have 20 fabricated parts in each resulting in a reduction in codes that need to be processed for the order.

X-PIECE

To deal with building tolerance issues, we have created a MecFlow X-piece. The X-piece, is a short length of pipe with a CLICKWELD fitting on one end. This can be cut into a pipe run using an electrofusion coupling to bring the system back into tolerance. Any offcuts will be recycled through the Polypipe recycling process.

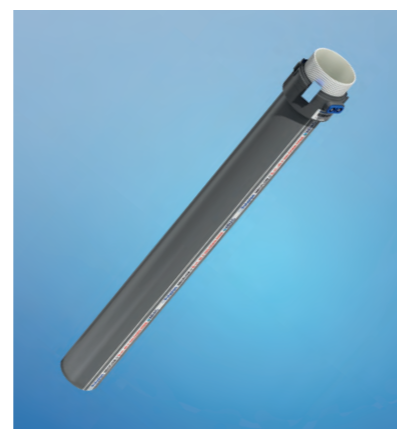

With the quality of support from the Polypipe Advantage team, you'll be updated on the progress of your MecFlow system order until it's delivered – on time and direct to site.



RECYCLABLE. SUSTAINABLE. SIMPLE.

MecFlow has been designed with reduced storage requirements and on-site waste in mind. Which is why the ends of each pipe are protected from dust and impact by fully recyclable end caps and plugs. We'll even collect any offcuts, caps and plugs from you for recycling once the job is complete.



4. Chemical resistance

The use of thermoplastic pipe systems within the commercial market is now widespread. Thermoplastics have replaced traditional materials such as steel, ductile iron and copper. Because of this diversity of use, it is essential that the most suitable plastic material is matched to its proposed application.

This section will provide a guide to compatible material selection. The information within this section has been collated from tests carried out by both national and international standards organisations (ISO/TR10358:1993) as well as tests performed by independent test houses.

The tests were based on the use of pure chemicals. For mixed chemicals, we would advise that pilot tests should be undertaken in order to ascertain the resistance of the material under these circumstances.

PIPE JOINTS

Electrofusion joints are regarded as generally having the same chemical resistance as the material itself. However, the jointing process can leave a certain amount of residual stress within the joint.

SEALS AND SEAT MATERIALS

The working life of seals and seat materials is often different from that of the pipe system and greatly dependent on the working conditions involved.

Tables 4.01 and 4.02 outline their resistance.

SEAL AND SEAT MATERIAL	
MATERIAL TYPE	RESISTANCE
EDPM-Ethylene Propylene Rubber	Satisfactory resistance to most aggressive chemicals, not suitable for oils or fat
FPM-Fluorine Rubber	The most resistant of the elastomers to solvents
NBR-Nitrile Rubber	Not resistant to oxidising agents, but resists petrol and oils
PTFE-Polytetrafluoroethylene	Resists all the chemicals shown in tables

Table 4.01

TERMINOLOGY FOR CHEMICAL RESISTANCE TABLES	
SYMBOL/TERM	DESCRIPTION
	Resistant
○	Conditionally resistant
×	Not recommended
-	No test data available
Technical grade	Technically pure
Saturated	Media has reached its maximum absorption in water at ambient temperature, which is the point where there can be no further absorption
Aqueous	A solution below maximum absorption, expressed as a percentage (%) of saturation (concentration)
Suspension	Insoluble or partially soluble solid carried in an aqueous base normally prepared at ambient temperature
Commercial Proprietary Industrial	Self explanatory, grades of chemical named brands in general use

Table 4.02

Chemical resistance – table 4.03

MecFlow is made from PPR, please follow the column labeled Polypropylene.

CHEMICAL	CONCENTRATION	MATERIAL°C																						
		PVCu				ABS			PE			POLYPROPYLENE			EPDM			FPM						
		20	40	60		20	40	60		20	40	60		20	60	100		20	40	60		20	60	100
Acetaldehyde	40%aqueoussolution	○	×	-		×	-	-			○		○	○			○	○			○	-	-	
Acetaldehyde	Technically pure	×	-	-		×	-	-			○	-	○	×	-		○	×	○	×	-	-	-	
Acetic acid	50% Aqueous			○		×	-	-									○	-	○	-	-	-	-	
Acetic acid	Technically pure glacial	○	×	-		×	-	-			○						○	-	×	-	-	-	-	
Acetic acid anhydride	Technically pure	×	-	-		×	-	-			○	-				○	-	-	×	-	-	-	-	
Acetic acid ethylester		×	-	-		×	-	-			-	-				-	-	○	-	-	-	-	-	
Acetic acid isobutyl ester	Technically pure	×	-	-		×	-	-			-	-				-	-	×	-	-	-	-	-	
Acetone	Up to 10% aqueous	×	-	-		○	-	-										○	×	-	-	-	-	
Acetone	Technically pure	×	-	-		×	-	-										×	-	-	-	-	-	
Acetonitrile	100%	×	-	-		×	-	-			○	-	-			○	-	-	×	-	-	-	-	
Acetophenone	100%	×	-	-		×	-	-			○	-	-			○	-	-	×	-	-	-	-	
Acrylic acid methyl ester	Technically pure	×	-	-		×	-	-			○	-	-			×	-	-	○	-	-	-	-	
Acrylicethyl	Technically pure	×	-	-		×	-	-			○	-	-			×	-	-	○	-	-	×	-	
Acrylonitrile	Technically pure	×	-	-		×	-	-										○	○	×	-	-	-	
Adipic acid	Saturated, aqueous			×		×	-	-																
Allyl alcohol	96%	○	×	-		×	-	-								○	-		○	○	-	-	-	
Ammonia	Gaseous technically pure					×	-	-																
Ammonium acetate	Aqueous, all			○		○	-	-																
Ammoniumpersulphate				○		-	-	-								○	-	-						
Ammonum salts, aqueous inorganic	Saturated					-	-	-																
Amyl acetate	Technically pure	×	-	-		×	-	-								○	×	-	○	-	-	×	-	
Amyl alcohol	Technically pure			○		×	-	-														○	-	
Aniline	Technically pure	×	-	-		×	-	-			○	-				○	-				○	○	-	
Antimony trichloride	90% Aqueous			-		×	-	-																
Aqua regia	Mixing ratio			○		×	-	-			×	-	-		×	-	-		×	-	-	○	-	
Arsenic acid	80% Aqueous			○																				
Barium salts, aqueous inorganic	Saturated					-	-	-																
Beer	Usual commercial			-		-	-	-																
Benzaldehyde	Saturated, aqueous	×	-	-		×	-	-			○	-							○					
Benzene	Technically pure	×	-	-		×	-	-			○	○	-		○	-	-		×	-	-	-	-	
Benzene sulfonic acid	Technically pure			-		-	-	-			○				○	-			○					

KEY: - NO DATA × NOT RECOMMENDED ○ CONDITIONALLY RESISTANT RESISTANT

The information in these tables has been supplied by other reputable sources and is to be used ONLY as a guide in selecting equipment for appropriate chemical compatibility. Before permanent installation, test the equipment with the chemicals and under the specific conditions of your application. Ratings of chemical behaviour listed in this chart apply to a 48-hr exposure period, we have no knowledge of possible effects beyond this period. We do not warrant (neither express or implied) that the information in this chart is accurate or complete or that any material is suitable for any purpose.

Chemical resistance – table 4.08

MecFlow is made from PPR, please follow the column labeled Polypropylene.

CHEMICAL	CONCENTRATION	MATERIAL °C																		
		PVCu			ABS			PE			POLYPROPYLENE			EPDM			FPM			
		20	40	60	20	40	60	20	40	60	20	60	100	20	40	60	20	60	100	120
Methyl amine	32% Aqueous	○	-	-	x	-	-	-	-	-	-	-	-	-	-	-	x	-	-	-
Methyl bromide	Technically pure	x	-	-	x	-	-	○	-	-	x	-	-	x	-	-	○	-	-	-
Methyl ethyl ketone	Technically pure	x	-	-	x	-	-	-	-	-	-	-	-	-	-	-	x	-	-	-
Methyl isobutyl ketone		x	-	-	x	-	-	-	-	-	-	-	-	-	-	-	x	-	-	-
Methyl methacrylate		x	-	-	x	-	-	-	-	-	-	-	-	-	-	-	x	-	-	-
Methylphenyl(acetophenon)		x	-	-	x	-	-	-	-	-	-	-	-	-	-	-	x	-	-	-
Milk														-	-	-	-	-	-	-
Mineral water																				
Mixed acids - nitric 15% - hydrofluoric 15% - sulphuric 18%	3 parts 1 part 2 parts	-	-	-	x	-	-	○	-	-	x	-	-	x	-	-	-	-	-	-
Mixed acids - sulphuric - nitric - water	10% 20% 70%				x	-	-	-	-	-	x	-	-	x	-	-	-	-	-	-
Mixed acids - sulphuric - nitric - water	50% 33% 17%	○	-	-	x	-	-	x	-	-	x	-	-	x	-	-	-	-	-	-
Mixed acids - sulphuric - nitric - water	50% 31% 19%	-	-	-	x	-	-	x	-	-	x	-	-	x	-	-	-	-	-	-
Mixed acids - sulphuric - phosphoric - water	30% 60% 10%				x	-	-													
N, N-Dimethylaniline	Technically pure	x	-	-	x	-	-	-	-	-	-	-	-	-	-	-	-	-	-	-
N, methylpyrrolidon		x	-	-	x	-	-	-	-	-	-	-	-	-	-	-	○	-	-	-
Naphthalene	Technically pure	x	-	-	-	-	-	-	-	-	-	-	-	x	-	-	-	-	-	-
Nickel salts, aqueous in organic	≥Saturated acid			○	-	-	-													
Nitrating acid - sulphuric acid - nitric acid - water	65% 20% 15%	○	-	-	-	-	-	x	-	-	x	-	-	x	-	-	-	-	-	-
Nitric acid	6.3% Aqueous							○	-	-	○	-	-							
Nitric acid	≥25%				x	-	-		○											
Nitric acid	65% Aqueous	○	○	x	x	-	-	○	x	-	x	-	-	x	-	-	x	-	-	-
Nitric acid	85%	x	-	-	x	-	-	x	-	-	x	-	-	x	-	-	-	-	-	-
Nitric acid	100%	x	-	-	x	-	-	x	-	-	x	-	-	x	-	-	x	-	-	-

KEY: - NO DATA x NOT RECOMMENDED ○ CONDITIONALLY RESISTANT RESISTANT

The information in these tables has been supplied by other reputable sources and is to be used ONLY as a guide in selecting equipment for appropriate chemical compatibility. Before permanent installation, test the equipment with the chemicals and under the specific conditions of your application. Ratings of chemical behaviour listed in this chart apply to a 48-hr exposure period, we have no knowledge of possible effects beyond this period. We do not warrant (neither express or implied) that the information in this chart is accurate or complete or that any material is suitable for any purpose.

Chemical resistance – table 4.09

MecFlow is made from PPR, please follow the column labeled Polypropylene.

CHEMICAL	CONCENTRATION	MATERIAL °C																		
		PVCu			ABS			PE			POLYPROPYLENE			EPDM			FPM			
		20	40	60	20	40	60	20	40	60	20	60	100	20	40	60	20	60	100	120
Nitrobenzene	Technically pure	x	-	-	x	-	-	-	-	-	-	-	-	○	-	-	-	-	-	-
Nitrotoluene (o-, m-, p-)	Technically pure	x	-	-	x	-	-	○	-	-	○	-	-	x	-	-	○	-	-	-
Nitrous acid					x	-	-	-	-	-	x	-	-	-	-	-	-	-	-	-
Nitrous gases (nitric oxide)	Diluted, moist, anhydrous				x	-	-	○	-	-	○	-	-	○	-	-	-	-	-	-
Oleic	Technically pure				x	-	-	○	-	-	○	-	-	x	-	-	x	-	-	-
Oleum	10% SO3	x	-	-	x	-	-	x	-	-	x	-	-	x	-	-	x	-	-	-
Olive oil					x	-	-	○	-	-	-	-	-	x	-	-	-	-	-	-
Oxygen	Technically pure							○	-	-	○	-	-							
Ozone	Up to 2%, in air				x	-	-	○	-	-	○	-	-	○	-	-	-	-	-	-
Ozone	Cold saturated, aqueous				x	-	-	○	-	-	○	-	-	x	-	-	-	-	-	-
Palm oil, palm nut oil														x	-	-	-	-	-	-
Paraffin emulsions	Usual commercial, aqueous													x	-	-	-	-	-	-
Paraffin oil					○	-	-	-	-	-	-	-	-	x	-	-	-	-	-	-
Perchlorid acid	10% Aqueous																			
Perchlorid acid	70% Aqueous				x	-	-	-	-	-	x	-	-	x	-	-	-	-	-	-
Perchloroethylene (tetrachlorethylene)	Technically pure	x	-	-	-	-	-	○	-	-	○	-	-	x	-	-	-	-	-	-
Phenol	Up to 10% aqueous	○	-	-	x	-	-		○						○					
Phenol	Up to 90% aqueous	○	-	-	x	-	-		○					x	-	-	x	-	-	-
Phosgene	Gaseous technically pure	○	○		x	-	-	○	-	-	○	-	-	-	-	-	○	-	-	-
Phosgene	Liquid, technically pure	x	-	-	x	-	-	x	-	-	x	-	-	x	-	-	-	-	-	-
Phosphoric acid	85% Aqueous														○			○		-
Phosphoric acid	Up to 95%				x	-	-							○	-	-	○	-	-	-
Phosphorous chlorides - trichloride - pentachloride - oxichloride	Technically pure	x	-	-	x	-	-	x	-	-	x	-	-	-	-	-	x	-	-	-
Photographic developer	Usual commercial			○					○											
Photographic emulsions																				
Photographic fixer	Usual commercial			○					○											
Phthalic acid	Saturated, aqueous	○	x		x	-	-								○	-	x	-	-	-
Potassium hydroxide	50%													○	-	-	x	-	-	-

KEY: - NO DATA x NOT RECOMMENDED ○ CONDITIONALLY RESISTANT RESISTANT

The information in these tables has been supplied by other reputable sources and is to be used ONLY as a guide in selecting equipment for appropriate chemical compatibility. Before permanent installation, test the equipment with the chemicals and under the specific conditions of your application. Ratings of chemical behaviour listed in this chart apply to a 48-hr exposure period, we have no knowledge of possible effects beyond this period. We do not warrant (neither express or implied) that the information in this chart is accurate or complete or that any material is suitable for any purpose.

Chemical resistance – table 4.10

MecFlow is made from PPR, please follow the column labeled Polypropylene.

CHEMICAL	CONCENTRATION	MATERIAL°C																				
		PVCu			ABS			PE			POLYPROPYLENE			EPDM			FPM					
		20	40	60	20	40	60	20	40	60	20	60	100	20	40	60	20	60	100	120		
Potassium aluminium salts, (alum), aqueous, inorganic	≤Saturated acid				-	-	-															
Potassium persulphate (potassium peroxodisulfate)	All, aqueous			○																		
Potassium hypochlorite			○						○										○			
Propane	Technically pure, gaseous							○														
Propane	Technically pure, liquid																					
Propanol, n- and iso-	Technically pure		○	○					○					○								
Propionic acid	50% Aqueous			○															○			
Propionic acid	Technically pure			○					○	○				○								
Propylene glycol	<50%																		○			
Propylene glycol	Technically pure																					
Pyridine	Technically pure		x						○	○				○						x		
Salicylic acid	Saturated																					
Sea water				○																		
Silicic acid																						
Silicone oil			○	x																		
Silver salts, aqueous, inorganic	≤Saturated acid																					
Sodium chlorite	Diluted, aqueous								○					○								
Sodium hypochlorite	12.5% Active chlorine, aqueous								○	○									○			
Sodium persulphate	Cold saturated, aqueous			○																		
Sodium salts, aqueous, inorganic	≤Saturated acid																					
Stannous chloride	Cold saturated, aqueous			○	○																	
Starch solution	Aqueous all																					
Styrene			x																			
Succinic acid	Aqueous, all																					
Sulfuryl chloride	Technically pure		x						x					x								
Sulphur dioxide	Technically pure, liquid		x						x					x					○			
Sulphur dioxide	All, moist			○										○						x		
Sulphuric acid	Saturated aqueous			○																○		
Sulphuric acid	Up to 80% aqueous													○	○				○	○	x	
Sulphuric acid	Up to 96% aqueous			○					x					x								

KEY: – NO DATA x NOT RECOMMENDED ○ CONDITIONALLY RESISTANT RESISTANT

The information in these tables has been supplied by other reputable sources and is to be used ONLY as a guide in selecting equipment for appropriate chemical compatibility. Before permanent installation, test the equipment with the chemicals and under the specific conditions of your application. Ratings of chemical behaviour listed in this chart apply to a 48-hr exposure period, we have no knowledge of possible effects beyond this period. We do not warrant (neither express or implied) that the information in this chart is accurate or complete or that any material is suitable for any purpose.

Chemical resistance – table 4.11

MecFlow is made from PPR, please follow the column labeled Polypropylene.

CHEMICAL	CONCENTRATION	MATERIAL°C																				
		PVCu			ABS			PE			POLYPROPYLENE			EPDM			FPM					
		20	40	60	20	40	60	20	40	60	20	60	100	20	40	60	20	60	100	120		
Sulphuric acid	98%			○																x		
Tannic acid	Aqueous all																					
Tetrachlorethylene (perchloroethylene)			x																			
Tetrachloroethane	Technically pure		x																			
Tetraethylene lead	Technically pure																					
Tetrahydrofuran	Technically pure		x																			
Tin salts, aqueous, inorganic	≤Saturated acid																					
Toluene	Technically pure		x																			
Trichloromethane	100%																					
Trichloroacetic acid	50% Aqueous			○																		
Trichloroacetic acid	Technically pure		○																			
Trichloroethane	Technically pure		x																			
Trichloroethylene	Technically pure		x																			
Triethylamine	Technically pure		x																			
Trifluoroacetic acid	Up to 50%		x																			
Turpentine oil	Technically pure		○																			
Urea	Up to 30% aqueous			○																		
Urine				○																		
Vinyl acetate	Technically pure		x																			
Vinyl chloride	Technically pure		x																			
Waste gases, containing alkaline																						
Wastegases, containing hydrochloric acid	All																					
Wastegases, containing hydrogen fluoride	Traces																					
Wastegases, containing nitrous gases	Traces																					
Wastegases, containing sulphur dioxide	Traces		○																			
Water, drinking, chlorinated	≤0.1ppm Chlorine																					
Water - distilled - deionised																						
Xylene	Technically pure		x																			
Zinc salts, aqueous, inorganic	≤Saturated acid																					

KEY: – NO DATA x NOT RECOMMENDED ○ CONDITIONALLY RESISTANT RESISTANT

The information in these tables has been supplied by other reputable sources and is to be used ONLY as a guide in selecting equipment for appropriate chemical compatibility. Before permanent installation, test the equipment with the chemicals and under the specific conditions of your application. Ratings of chemical behaviour listed in this chart apply to a 48-hr exposure period, we have no knowledge of possible effects beyond this period. We do not warrant (neither express or implied) that the information in this chart is accurate or complete or that any material is suitable for any purpose.

5. System sizing

For successful, long-lasting system performance, system sizing is crucial.

A number of factors must be taken into account by the Design Engineer, and the system must be designed in accordance with design recommendations, including:

- BS 1997
- BS EN 806
- BS 8558:2015
- IOP design guide 2002
- WRAS Water Regulation Guidelines
- CIBSE guide G and C

The following section details the key parameters of the system that must be considered in order to complete a satisfactory design.



Diameter equivalence – between MecFlow and copper pipes

QUICK EQUIVALENCE TABLE	
CU PIPE DIAMETER mm	MECFLOW PIPE DIAMETER mm
12	20
15	20
18	20
22	25
28	32
35	40
42	50
54	63
67	75
76.1	90
89.9	110
108	125

Table 5.01

NOTE: For accurate sizing please refer to MecFlow Temperature and Pressure ratings table on page 32, Table 5.09.

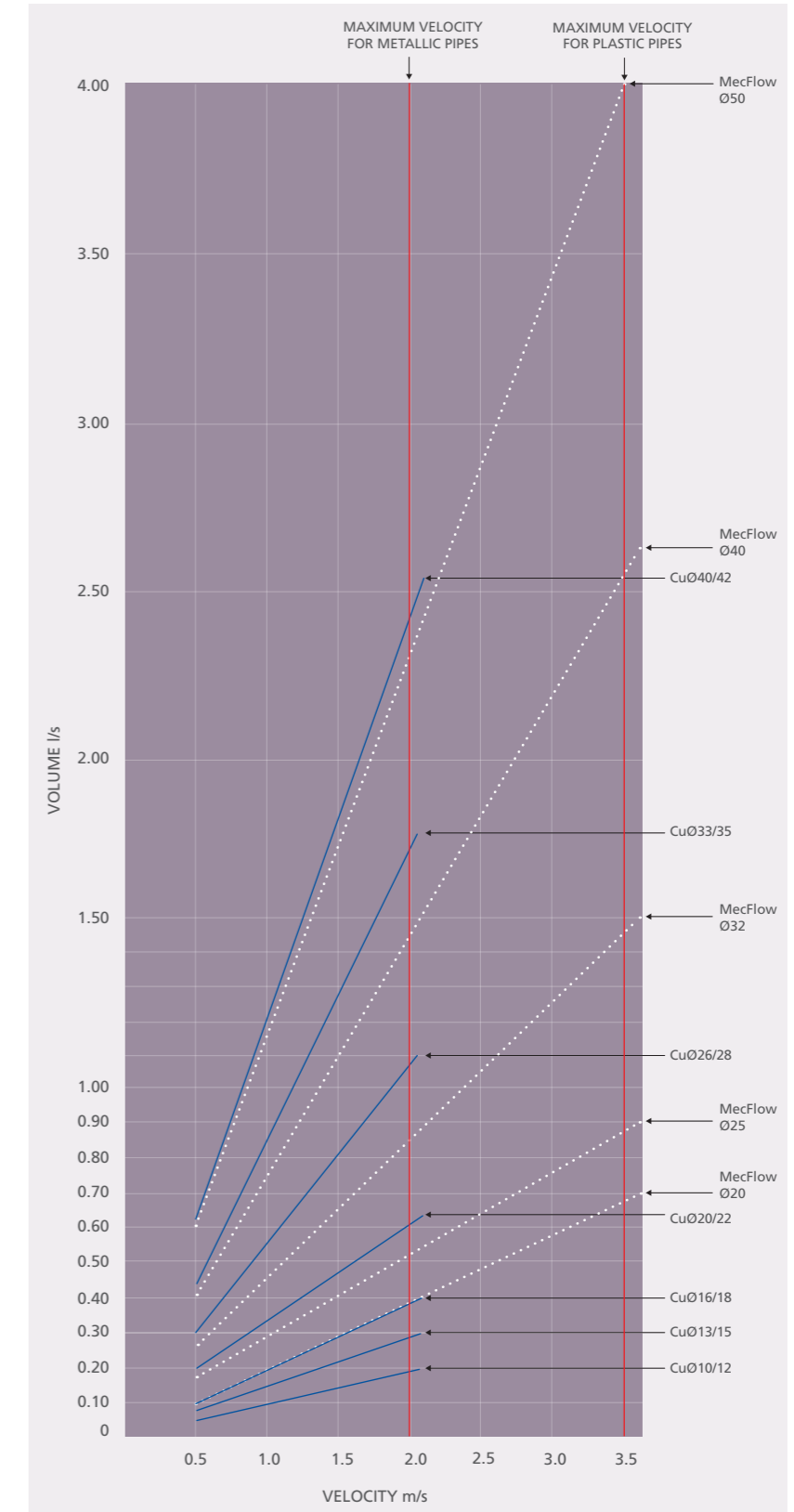

Graph 5.02

Diameter equivalence – between MecFlow and steel pipes

QUICK EQUIVALENCE TABLE	
STEEL O/D inches	MECFLOW O/D mm
3/8	20
1/2	20
3/4	25
1	32
1 1/4	40
1 1/2	50
2	63
2 1/2	75
3	90
4	110
5	125
6	160

This table shows threaded steel, thin wall steel should follow the Copper table 5.01.

Table 5.03

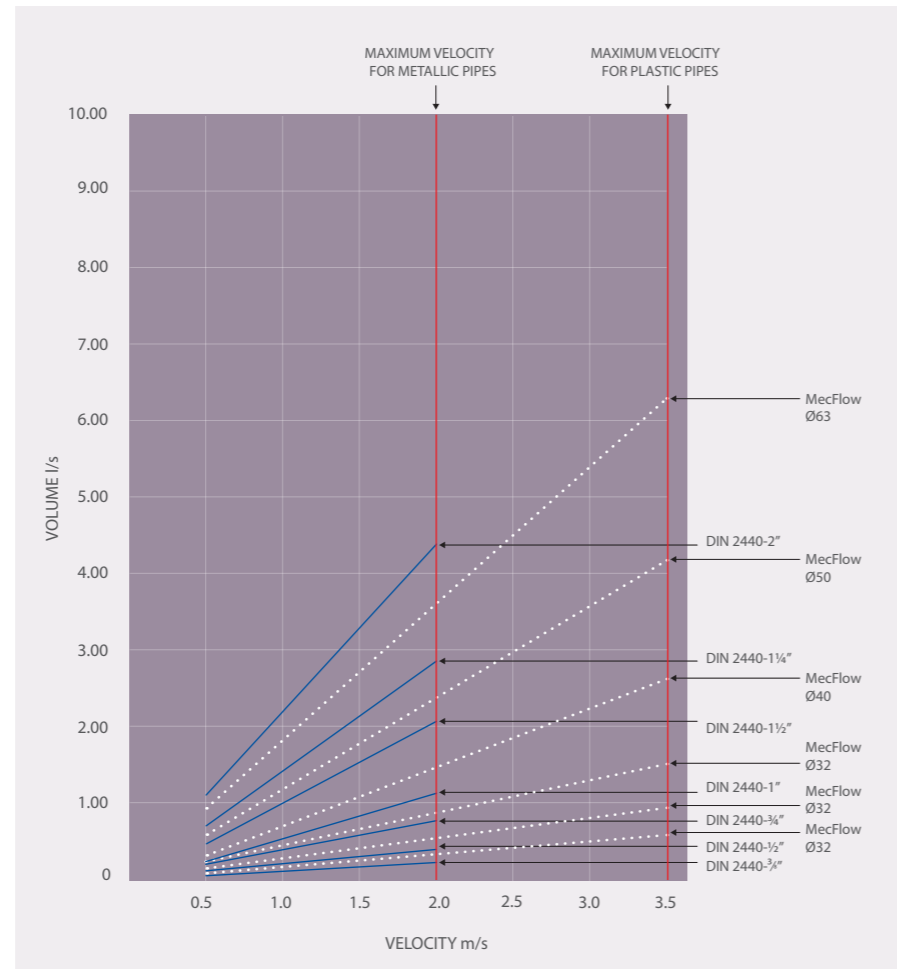

Graph 5.04

Diameter equivalence – between MecFlow and steel pipes 75mm to 200mm

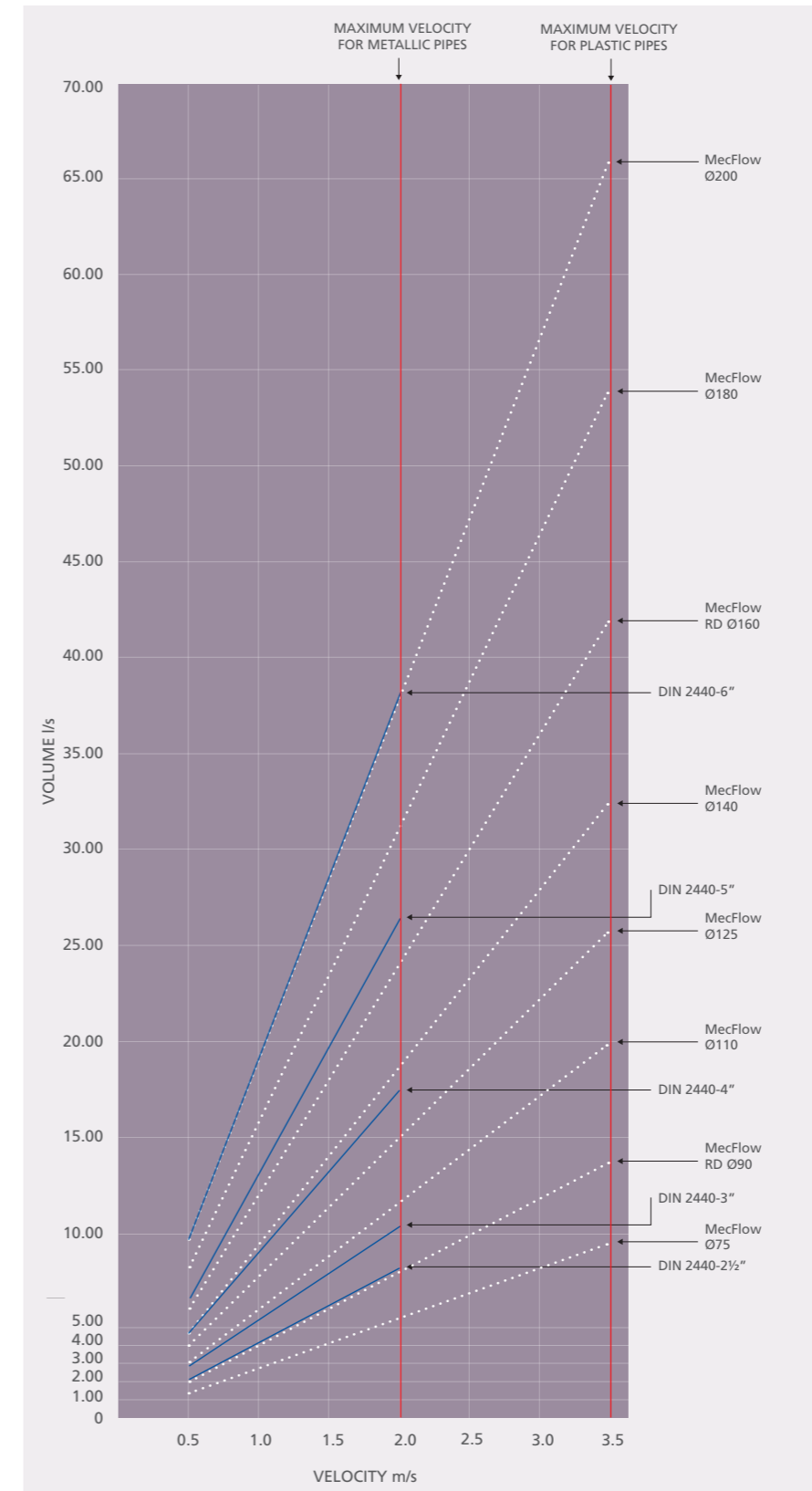

Graph 5.05

Co-efficient of Loss (ϕ) – by product type



















FITTING	PRODUCT IMAGE	SYMBOL	COMMENT	z-VALUE
Tee in derivation				1.30
Tee of reduced influx				0.90
Tee in reduced derivation				0.30
Tee of influx				0.60
Elbow				1.13
Conic expansion $\beta = 10^\circ$ $\beta = 20^\circ$ $\beta = 30^\circ$ $\beta = 40^\circ$				0.20 0.45 0.60 0.75
Expansion with free unload				1.00
Reducer			1 diameter 2 diameters 3 diameters 4 diameters 5 diameters 6 diameters	0.40 0.50 0.60 0.70 0.80 0.90
Ball valve			DN 20 aDN 25 DN 32 aDN 50 DN 65 aDN 80 to DN 100	1.5 1 0.7 0.6

Table 5.06  = Flow direction

FITTING	PRODUCT IMAGE	SYMBOL	COMMENT	z-VALUE
Socket				0.25
Reducer large ϕ to small ϕ			Reduction by: 1 dimension 2 dimension 3 dimension 4 dimension 5 dimension 6 dimension	0.40 0.50 0.60 0.70 0.80 0.90
Elbow 90°			Up to 160mm	1.20
Segment elbow 90° (200 - 630mm)			200mm and above	0.80
Elbow 45°			Up to 160mm	0.50
Elbow 45° male/female				0.50
Tee				0.25
			Separation of flow	1.20
			Conjunction of flow	0.80
			Counter current in case of separation of flow	1.80
			Counter current in case of conjunction of flow	3.00
Reducing tee			The z-value results from the addition of tee and reducer	

Table 5.07  = Flow direction

Co-efficient of Loss (ϕ) – by product type













FITTING	PRODUCT IMAGE	SYMBOL	COMMENT	z-VALUE
Weld-in saddle				0.25
			Separation of flow	0.5
			Counter current in case of conjunction of flow	1.00
Transition piece with female thread				0.50
Transition piece with male thread				0.70
Elbow with female thread				1.40
Elbow with male thread				1.60
Transition tee with female thread			-16 x 1/2" x 16 -20 x 3/4" x 20	1.40
			-20 x 1/2" x 20 -25 x 3/4" x 25 -32 x 1" x 32	1.60
			-25 x 1/2" x 25 -32 x 1" x 32	1.80
Ball valve				-20mm -25mm -32mm -40mm -50mm -60mm

Table 5.08  = Flow direction

MecFlow Temperature and Pressure Ratings

TEMPERATURE	YEARS OF SERVICE	MECFLOW DIAMETERS 20 - 32mm		MECFLOW DIAMETERS 40 - 400mm	
		BAR	PSI	BAR	PSI
10°C	1	39.20	568.52	25.08	363.75
	5	38.20	554.04	24.40	353.89
	10	37.57	544.90	24.04	348.67
	25	36.75	533.01	23.52	341.12
	50	36.50	529.38	23.36	338.80
20°C	100	35.95	521.41	23.00	333.58
	1	34.15	495.30	21.85	316.90
	5	33.05	479.34	21.15	306.75
	10	32.77	474.70	20.97	304.14
	25	32.00	464.12	20.48	297.03
30°C	50	31.70	459.76	20.30	294.42
	100	31.10	451.79	19.93	289.06
	1	29.80	432.21	19.08	276.73
	5	29.00	420.60	18.56	269.19
	10	28.45	412.63	18.20	263.96
40°C	25	27.90	404.65	17.85	258.89
	50	27.62	400.59	17.68	256.42
	100	27.05	392.32	17.31	251.06
	1	26.05	377.82	16.67	241.77
	5	25.20	365.49	16.12	233.80
50°C	10	24.65	357.51	15.77	228.72
	25	24.37	353.45	15.60	226.25
	50	23.82	345.47	15.24	221.03
	100	23.52	341.12	15.05	218.28
	1	23.05	334.31	14.75	213.93
60°C	5	22.17	321.54	14.19	205.80
	10	21.60	313.28	13.82	200.44
	25	21.30	308.93	13.63	197.78
	50	20.75	300.95	13.20	191.44
	100	20.45	296.60	13.00	188.54
70°C	1	19.37	280.93	12.40	179.84
	5	18.80	272.67	12.03	174.48
	10	18.50	268.31	11.84	171.72
	25	17.92	259.90	11.47	166.35
	50	17.70	256.71	11.30	163.89
80°C	1	16.55	240.03	10.59	153.59
	5	15.67	227.27	10.00	145.03
	10	15.40	223.35	9.85	142.86
	25	15.10	219.00	9.66	140.10
	50	14.90	216.10	9.50	137.78
95°C	1	13.82	200.44	8.84	128.21
	5	13.22	191.73	8.46	122.70
	10	12.92	187.38	8.27	119.94
	25	12.70	184.19	8.10	117.48
	5	10.75	155.91	6.88	99.78
		10.15	147.21	6.49	94.12

Table 5.09

MecFlow pressure loss tables

The following pressure loss tables can be used as a design guide. To identify the correct pressure loss value, follow these steps:

- Step 1**
Look up the required flow system flow rate
- Step 2**
Reference the design velocity
- Step 3**
Identify the chosen diameter
- Step 4**
Read the R-value - loss mbar/m

FLOW l/s		EXTERNAL DIAMETER mm		32	Step 3
		20	25		
		THICKNESS mm	2.8	3.5	4.4
		INTERNAL DIAMETER mm	14.4	18.0	23.2
		'R'- PRESSURE LOSS (mbar/m)	'V'- VELOCITY (m/s)		
0.32	R	32.86	11.21	3.33	Step 1
	V	1.96	1.26	0.76	
0.34	R	36.62	12.48	3.70	Step 1
	V	2.09	1.34	0.80	
0.36	R	40.56	13.80	4.09	Step 1
	V	2.21	1.41	0.85	
0.38	R	44.69	15.19	4.50	Step 1
	V	2.33	1.49	0.90	
0.40	R	49.00	16.64	4.92	Step 1
	V	2.46	1.57	0.95	
0.45	R	60.59	20.51	6.05	Step 1
	V	2.76	1.77	1.06	
0.50	R	73.32	24.76	7.28	Step 1
	V	3.07	1.96	1.18	
0.55	R	87.19	29.38	8.62	Step 1
	V	3.38	2.16	1.30	
0.60	R	102.18	34.35	10.06	Step 1
	V	3.68	2.36	1.44	
0.65	R	116.60	39.69	11.60	Step 1
	V	2.55	1.54	1.54	
0.70	R	131.60	45.38	13.28	Step 1
	V	2.75	1.66	1.66	
0.75	R	147.20	51.43	14.98	Step 1
	V	2.95	1.77	1.77	
0.80	R	163.40	57.84	16.81	Step 1
	V	3.14	1.89	1.89	
0.85	R	180.20	64.60	18.75	Step 1
	V	3.34	2.01	2.01	
0.90	R	197.60	71.71	20.78	Step 1
	V	3.54	2.13	2.13	
0.95	R	215.60	79.16	22.91	Step 1
	V	3.74	2.25	2.25	
1.00	R	234.20	86.95	25.13	Step 1
	V	3.94	2.37	2.37	
1.10	R	276.80	101.40	29.86	Step 1
	V	4.34	2.60	2.60	
1.20	R	320.40	116.60	34.98	Step 1
	V	4.74	2.84	2.84	
1.30	R	365.00	132.60	40.47	Step 1
	V	5.14	3.08	3.08	
1.40	R	410.60	149.30	46.34	Step 1
	V	5.54	3.31	3.31	
1.50	R	457.20	166.80	52.58	Step 1
	V	5.94	3.55	3.55	

Table 5.10

MecFlow – pressure loss

FLOW l/s	EXTERNAL DIAMETER mm	40	50	63	75	90	110	125	160	200	250	315	400	
	THICKNESS mm	3.7	4.6	5.8	6.8	8.2	10	11.4	14.6	18.2	22.7	28.6	36.3	
	INTERNAL DIAMETER mm	32.6	40.8	51.4	61.4	73.6	90.0	102.2	130.8	163.6	204.6	257.8	327.4	
	'R'– PRESSURE LOSS (mbar/m)	'V'– VELOCITY (m/s)												
77.00	R											1.73	0.56	0.18
	V											2.34	1.48	0.91
77.50	R											1.75	0.57	0.18
	V											2.36	1.48	0.92
78.00	R											1.77	0.57	0.18
	V											2.37	1.49	0.93
78.50	R											1.79	0.58	0.18
	V											2.39	1.50	0.93
79.00	R											1.81	0.59	0.18
	V											2.40	1.51	0.94
79.50	R											1.83	0.59	0.19
	V											2.42	1.52	0.94
80.00	R											1.85	0.60	0.19
	V											2.43	1.53	0.95
80.50	R											1.87	0.61	0.19
	V											2.45	1.54	0.96
81.00	R											1.89	0.61	0.19
	V											2.46	1.55	0.96
81.50	R											1.92	0.62	0.19
	V											2.48	1.56	0.97
82.00	R											1.94	0.63	0.20
	V											2.49	1.57	0.97
82.50	R											1.96	0.63	0.20
	V											2.51	1.58	0.98
83.00	R											1.98	0.64	0.20
	V											2.52	1.59	0.99
83.50	R											2.03	0.65	0.20
	V											2.55	1.60	0.99
84.00	R											2.05	0.66	0.21
	V											2.57	1.61	1.00
84.50	R											2.07	0.66	0.21
	V											2.59	1.62	1.00
85.00	R											2.30	0.67	0.21
	V											2.74	1.63	1.01
90.00	R											2.55	0.74	0.23
	V											2.89	1.72	1.07
95.00	R											2.80	0.82	0.26
	V											3.04	1.82	1.13
100.00	R											3.35	0.90	0.28
	V											3.35	1.97	1.19
110.00	R											3.94	1.08	0.34
	V											3.65	2.11	1.31
120.00	R											1.26	0.39	
	V											2.30	1.43	
130.00	R											1.47	0.46	
	V											2.49	1.54	
140.00	R											1.68	0.52	
	V											2.68	1.66	
150.00	R											1.91	0.59	
	V											2.87	1.78	

Table 5.20

MecFlow – pressure loss

FLOW l/s	EXTERNAL DIAMETER mm	40	50	63	75	90	110	125	160	200	250	315	400	
	THICKNESS mm	3.7	4.6	5.8	6.8	8.2	10	11.4	14.6	18.2	22.7	28.6	36.3	
	INTERNAL DIAMETER mm	32.6	40.8	51.4	61.4	73.6	90.0	102.2	130.8	163.6	204.6	257.8	327.4	
	'R'– PRESSURE LOSS (mbar/m)	'V'– VELOCITY (m/s)												
160.00	R												2.16	0.67
	V												3.07	1.90
170.00	R												2.42	0.75
	V												3.26	2.02
180.00	R												2.69	0.83
	V												3.45	2.14
190.00	R												2.98	0.92
	V												3.64	2.26
200.00	R												1.01	
	V												2.38	
220.00	R												1.11	
	V												2.49	
220.00	R												1.21	
	V												2.61	
230.00	R												1.31	
	V												2.73	
240.00	R												1.42	
	V												2.85	
250.00	R												1.53	
	V												2.97	
260.00	R												1.65	
	V												3.09	
270.00	R												1.77	
	V												3.21	
280.00	R												1.89	
	V												3.33	
290.00	R												2.02	
	V												3.44	
300.00	R												2.15	
	V												3.56	

Table 5.21

6. Jointing methods

Thermo-form welding

One advantage of MecFlow over traditional water supply systems is its ability to offer thermo-form welded joints, creating a consistent, robust joint for the lifecycle of the installation.

Effectively eliminating the boundary between the pipe and the fitting, thermo-form welding provides a homogenous joint, bonded at a molecular level, effectively making the join as strong as the pipe itself. The MecFlow system has three methods of thermo-form welding: butt fusion, socket fusion, and electrofusion, all of which use a heat source to facilitate an effective weld process. Using electrofusion system technology, the patented CLICKWELD technology system provides a unique, robust and simple jointing method.

Table 6.01 shows the diameters which can be welded via each process.

PIPE Ø	WELDING OPTIONS			
	SOCKET FUSION	BUTT FUSION	ELECTROFUSION	CLICKWELD
20	3		3	
25	3		3	
32	3		3	
40	3	3	3	
50	3	3	3	3
63	3	3	3	3
75	3	3	3	3
90	3	3	3	3
110	3	3	3	3
125	3	3	3	3
160		3	3	
200		3	3	
250		3		

Table 6.01

KEY
3 = Available
= Coming soon

MECHANICAL JOINTING

In addition to thermo-form welding, a large range of threaded and flanged jointing methods are available, allowing the MecFlow system to be jointed to other materials, and to connect valves and other system components.



Jointing preparation

PIPE CUTTING

There are a number of methods of correctly cutting pipe prior to joining. In all cases, the cut pipe should be square and de-burred. Additional preparation steps are included in the specific welding instructions as and when required. The cutting method and post-cutting preparation are detailed below.

Manual pipe cutting

While these are the recommended cutting methods, other methods can be used, provided the pipe isn't damaged as a result. All cuts should be square, with less than 5° of deviation, and without any jagged edges.



Ratchet cutters with a sharp, pointed blade should be used for smaller pipe sizes, this prevents the pipe from deforming during cutting.



Hand saws may be used, however it is crucial to ensure the cut is square, and the edges are as smooth as possible.



Support the pipe during cutting to prevent movement, allowing the end to be cut as square as possible.

Recommendation: Mobile work benches can be used as a clamping device to achieve a 90 degree cut.



Alternatively, tube cutters can be used. Ensure the cutting wheel has a radius greater than the pipe wall.

DO NOT

Do not use tube cutters with a dull or flat blade. Blunt blades can oval the pipe and can cause an inconsistent cut.



Jointing preparation (continued)

Cutting using power tools

When using powered saws, blades intended for hardwood offer the best results. Where possible, avoid angled or jagged cuts, as additional preparation will be required prior to welding.



For a cut that requires minimal finishing work, use a 60-100T circular tungsten carbide blade suitable for cutting plastic.



Both band saws and reciprocating saws may also be used.

Recommendation: Ensure blade is sharp and between 10-14pt.

DO NOT

Do not cut the pipe using power tools where the temperature is below 4°C. Place the pipe in an environment with a higher ambient temperature before cutting.



A wide tooth blade will result in a rough jagged cut.



A fine toothed blade may overheat the pipe.

Inspection and cleaning/de-burring

ATTENTION !

A blunt or incorrect cutting tool may cause stresses during the cutting process, first check the cutting tool to ensure it is suitable. Pipe should not be cut below a temperature of 4°C

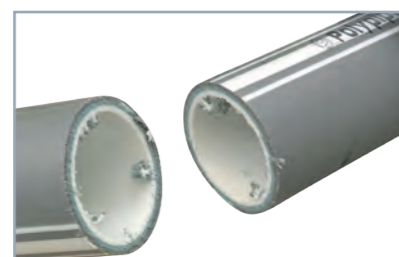

Once a cut is made, check the ends of the pipe for damage, both internally and externally. If any damage is identified, mark and remove the damaged area, cutting a few millimetres beyond the damage.



Dirt and oil can be removed from the pipe's surface using an isopropyl alcohol-based cleaner (91% by volume or greater).



Remove any debris left after cutting and de-burr using a de-burring tool or reaming tool.



A successful cut should be square, smooth and de-burred.

Polypipe Advantage off-site manufacturing

SOCKET FUSION WELDING

Socket fusion welding is carried out by heating the outer surface of the pipe and the socket of a corresponding fitting, before inserting the pipe into the fitting.

The pipe is then held in the socket and allowed to cool. This forms a homogenous bond, with the weld

surface covering the entire area of the pipe spigot/fitting socket insertion. For pipe diameters up to 63mm, this

process can be carried out by hand, however for diameters of 75mm and above, a socket fusion welding machine must be used.

Diagram 6.02



Pre-weld



Post-weld

HAND SOCKET FUSION WELDING – Ø20MM TO Ø63MM

Equipment and set-up

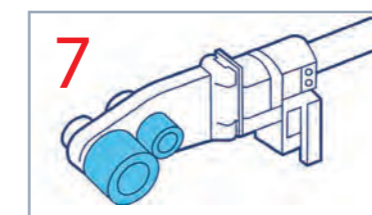
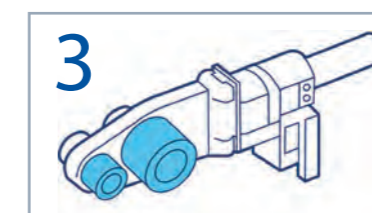
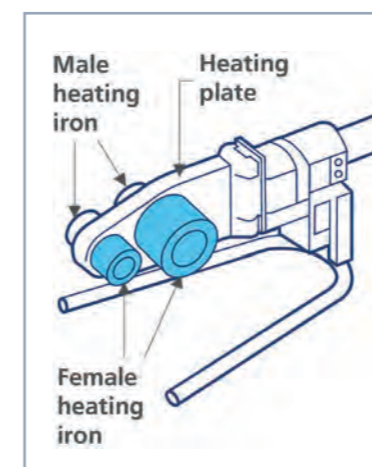

Diagram 6.03



1. Check the hand welding tool and relevant male/female irons for damage.

2. Before turning the hot plate on, the relevant male and female heating irons must be mounted onto the base hand welding device. Make sure they are fitted square.

a. The heating irons must be mounted into the correct hole on the hot plate, consult the tool's instruction manual if you are unsure which iron mounts to which hole.

b. It is crucial that the base of the heating iron is in full contact with the hot plate, as shown diagram 6.03 above.

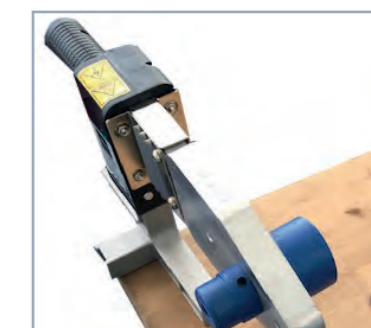

3. Plug the hand welding device in and allow it to reach the correct welding temperature. This should take between 10 and 30 minutes.



4. While the device is heating, re-tighten the bolts holding the male and female irons on to the hot plate.

Recommendation: Use safety gloves and sleeves, using an allen key to tighten.

Socket fusion welding

PRE-WELDING PROCESS

1. Before carrying out the first weld, check that the male and female irons have reached a temperature of 260°C.
2. Cut the pipe to the required length. The cut must be square and de-burred.
3. Bevel the pipe according to table 6.05.
4. Mark the pipe insertion depth on the pipe, as shown in table 6.05.
5. Mark the desired angular rotation of the fitting to the pipe. If the fitting is a coupling, or the first bend or branch, this step is not required.

WELDING PROCESS

PIPE OD mm	HEATING TIME (Seconds)	JOINT TIME (Seconds)	COOLING TIME	
			FIXED (Seconds)	TOTAL (Minutes)
			20	6
25	7	4	10	2
32	8	6	10	4
40	12	6	20	4
50	18	6	20	4
63	24	8	30	6
75	30	8	30	6
90	40	8	30	6
110	50	10	40	8
125	60	10	50	8

Table 6.04

WELDING PROCESS STEP-BY-STEP

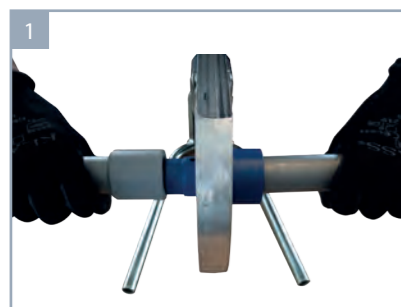

1. Pre-mark the insertion depth on each pipe. Push the pipe into the female iron and push the fitting on to the male iron. Insert to the mechanical stop. Do not twist the pipe or fitting.

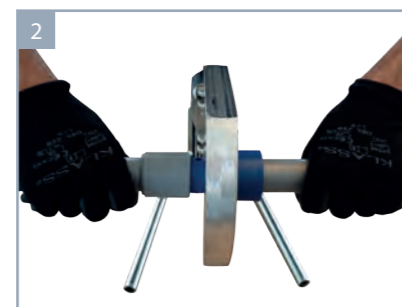

2. Once the pipe and fitting both reach the mechanical stop, apply heat for the required time.

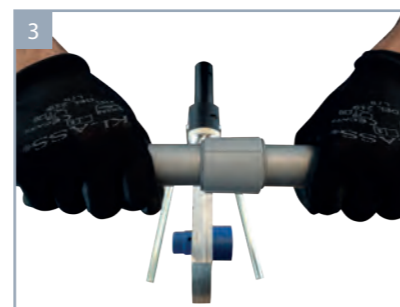

3. Once the heating time is reached, remove the pipe and fitting from the hot plate, and immediately push them together, without twisting, to the insertion depth marked on the pipe. This must be completed within the joint time listed in table 6.04. Continue to hold the pipe and fitting together for the duration of the cooling time specified in table 6.04.

Socket fusion welding (continued)

MACHINE SOCKET FUSION WELDING – Ø20MM TO Ø125MM

Equipment and Set-up



1. Place the socket welding machine on a secure bench. Set the correct diameter of the pipe being socket welded.
2. Set the machine up, including the following steps:
 - a. Attach the correct diameter clamps and supports.
 - b. Attach the hot plate.
 - c. Bolt the correct male/female irons to the hot plate, in their correct positions.



3. Turn the machine on and allow the hot plate to reach a temperature of 260°C. This should take between 10 and 30 minutes.



4. While waiting for the hot plate to reach the required temperature, adjust the pipe and fitting clamps to approximately the correct level, using the pipe and fittings as a guide.

Socket fusion welding (continued)

PRE-WELDING PROCESS

1. Before carrying out the first weld, check that the male and female irons have reached a temperature of 260°C.
2. Cut the pipe to the required length. The cut must be square and de-burred.
3. Bevel the pipe according to table 6.05.
4. Mark the pipe insertion depth on the pipe, as shown in diagram 6.06. (Only required when hand-welding).
5. Mark the desired angular rotation of the fitting to the pipe. If the fitting is a coupling, or the first bend or branch, this step is not required.

Diagram 6.06

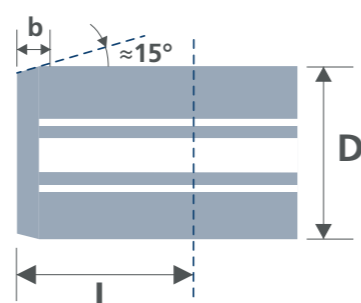

Ø PIPE 'D' mm	BEVELING 'b' mm	WELDING DEPTH 'L' mm
20	-	14
25	2	16
32	2	18
40	2	20
50	2	23
63	2	27
75	3	31
90	3	35
110	3	41
125	3	46

Table 6.05

WELDING PROCESS

There are a number of socket fusion machines available, each with different operation methods. The user should familiarise themselves with the correct method for their machine before welding.

PIPE OD mm	HEATING TIME (Seconds)	JOINT TIME (Seconds)	COOLING TIME	
			FIXED (Seconds)	TOTAL (Minutes)
20	6	4	6	2
25	7	4	10	2
32	8	6	10	4
40	12	6	20	4
50	18	6	20	4
63	24	8	30	6
75	30	8	30	6
90	40	8	40	6
110	50	10	50	8
125	60	10	60	8

Table 6.07

Socket fusion welding (continued)

Welding process step-by-step

1. Set the star wheel. Mount the pipe and socket into the machine. Socket (right) and pipe (left).
2. Using a methyl alcohol wipe, clean the pipe spigot and the fitting socket to be welded.
3. Set the machine cam to the correct Ø size to be welded.
4. Drop in the heated irons attached to the hot plate.
5. Move the pipe and fitting onto their socket/spigot irons.
6. Gently move the pipe and fitting to the stop points on their respective irons. Lightly maintain pressure so that they do not back off and keep the weld surface on the irons for the relevant heating time, as shown in table 6.07.
7. Once the heating time is reached, pull the star wheel back until pipe/spigot are free of heated irons and remove the hot plate.
8. Move the pipe spigot onto the fitting socket and move the pipe into the socket, the pre-set cam will insert the pipe into the socket at the pre-set depth.
9. Lightly maintain pressure on the machine bed to prevent the welding surfaces from separating.
10. Lock the bed off and leave the unit to cool for the time listed in table 6.07.
11. Once the cooling time has elapsed, remove the welded piece from the machine bed.

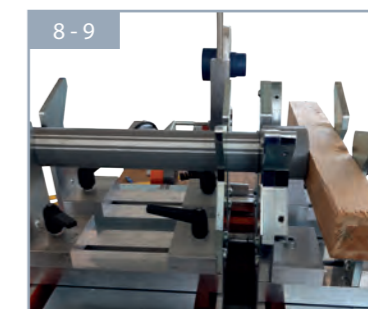
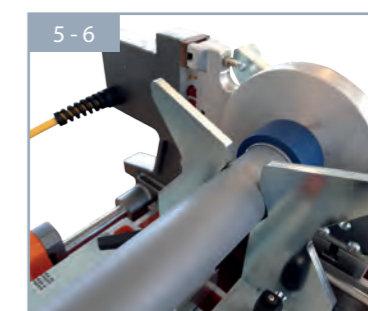
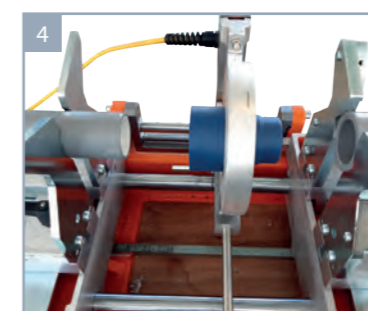
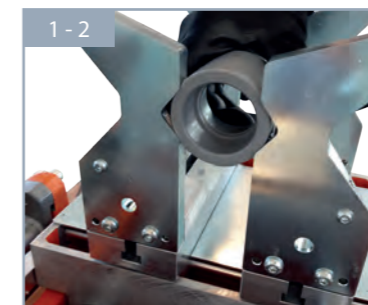

Butt fusion welding

BUTT FUSION WELDING – Ø160MM TO Ø400MM

Butt fusion welding is a process by which the ends of the pipes to be jointed are heated and then pressed together under a known force for a pre-determined cooling down period. This forms a homogenous weld throughout the butt weld surface.

Equipment and set-up

There are a number of butt fusion machines available from multiple manufacturers, ranging from manual to fully-automatic operation. The welding machine used should be suitable for use with MecFlow pipes and fittings, with a maximum SDR (diameter to wall thickness ratio) of 7.5. The machine must be placed in an environment with a stable temperature, without exposure to high winds. The equipment must:

1. Be set up on a secure base, at a comfortable working height.
2. Have the clamps set correctly for the diameter of the pipe that has to be welded.
3. Have a planner which can be used to square up both mating surfaces prior to heating.

Note: Example shown is on a counter-weight balance.

4. Have a hot plate which can be introduced to the mating surfaces throughout the heating cycle of the process. The hot plate must be capable of reaching 210°C ±10°C.
5. Feature a mechanical hand (Ø20mm to Ø125mm) or hydraulic (Ø160mm to 400mm) drive system to move the pipe surfaces together and clamp them to the correct force for the duration of any cycles which require pressure to be applied.
6. Include a manometer to take drag and clamp pressure readings.



Butt fusion welding (continued)

PRE-WELDING PROCESS

1. Before switching the machine on, check the surface of the hot plate for any damage to the teflon coating. Any damaged hot plates should be replaced.
2. Clean both surfaces of the hot plate with methyl alcohol.
3. Turn the machine on and allow the hot plate to reach a temperature of 210°C. Check this temperature with a thermometer before carrying out the first weld.
4. Cut the pipes to be jointed, ensuring the cuts are square.
5. While waiting for the hot plate to reach temperature, set the pipe clamps to the correct clamping force and check the function of the drive system and planing device.
6. Assemble the pipe pieces into the butt fusion machine and clamp accordingly. When working with long pipes, additional support may be required.
7. Once the pipes are clamped correctly, the drag pressure must be determined. Move the hydraulic drive and read the pressure on the manometer.
8. Bring the planing device into the bed of the machine, turn on and lightly bring the pipe surfaces to the planer.
9. Plane the pipe ends until they are flat to the planing device.
10. Remove the planing device and bring the mating surfaces together. They must align with a minimum axial deflection of ≤10% of the wall thickness.
11. When the pipes are together, check the gap between the planed ends. This should not exceed the dimension stated in table 6.10 at any point around the mating face's circumference.



Under no circumstances must the ends of the pipe be touched or contaminated from this point forward. If they are then they must be re-planed.



Butt fusion welding (continued)

BUTT WELDING PROCESS

There are a number of butt fusion machines available, each with different operation methods. The welding process should take place in a temperature stable environment above 5°C, avoiding areas of high winds. Welding should only be carried out once all pre-welding processes are completed satisfactorily.

There are five timed steps to follow for the butt fusion welding process. These timings vary depending on the diameter being welded.

Butt welding process step-by-step

STEP 1 – t1

Forming of the weld bead (under pressure).

STEP 2 – t2

Heating soak time (no pressure).

STEP 3 – t3

Removal of the heat element and bringing the mating faces together. This is a maximum time allowed for this step.

STEP 4 – t4

Pressure increase on the mating faces.

STEP 5 – t5

Cooling time (under pressure).

MAXIMUM SEPARATION OF THE PIPES PREPARED TO BE WELDED	
PIPE OD mm	SEPARATION mm
≤355	0.5
400 - <630	1.0
630 - <800	1.3
800 - ≤1000	1.5
>1000	2.0

Table 6.08

Diagram 6.09

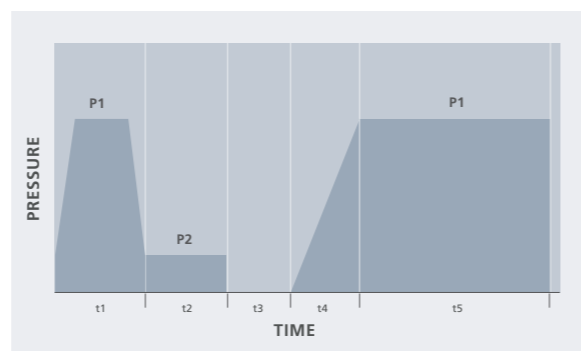

PARAMETERS OF BUTT WELDING ACCORDING TO DVS 2207-11					
PIPE THICKNESS mm	PROTRUDING OF THE INITIAL WELDING CORD *h mm	HEATING TIME t2 Seconds	TIME FOR REMOVING THE PLATE t3 Seconds	TIME FOR REACHING PRESSURE t4 Seconds	COOLING TIME t5 minutes
< 4,5	0.5	135	5	6	6
4,5 – 7	0.5	135 – 175	5 – 6	6 – 7	6 – 12
7 – 12	1.0	175 – 245	6 – 7	7 – 11	12 – 20
12 – 19	1.0	245 – 330	7 – 9	11 – 17	20 – 30
19 – 26	1.5	330 – 400	9 – 11	17 – 22	30 – 40
26 – 37	2.0	400 – 485	11 – 14	22 – 32	40 – 55
37 – 50	2.5	485 – 560	14 – 17	32 – 43	55 – 70

Table 6.10

The values for applied pressure by Ø are machine-specific and the operator must familiarise themselves with the relevant tables before beginning the welding process.

Butt fusion welding (continued)

STEP 1 – t1

The purpose of this step is to create a bead of material around the circumference of both mating surfaces (this is not the finished bead). The size of this bead is machine-specific and the operator should familiarise themselves with the machine instructions before beginning.

1. Clean the hot plate with a cotton cloth.
2. Bring the mating surfaces to the hot plate and apply the relevant pressure to the hot plate.
3. Begin t1 time sequence.
4. On completion of t1 move to Step 2 – t2.

STEP 2 – t2

1. Immediately after completing the time for t1, reduce the pressure on the mating surfaces such that the only pressure applied is to keep the mating surfaces in contact with the hot plate.
2. Begin t2 time sequence.
3. On completion of t2 move to Step 3 – t3.

STEP 3 – t3

Important: This step must be completed within the specified time

1. Immediately after completing t2, remove the mating faces from the hot plate.
2. Remove the hot plate from the machine bed.
3. Quickly bring the mating surfaces together.
4. Once the mating faces are together, move to Step 4 – t4.

Diagram 6.11 – t1 Showing up of the welding cord

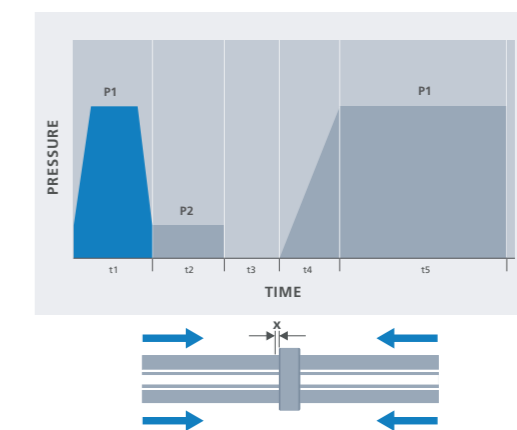

Diagram 6.12 – t2 Heating

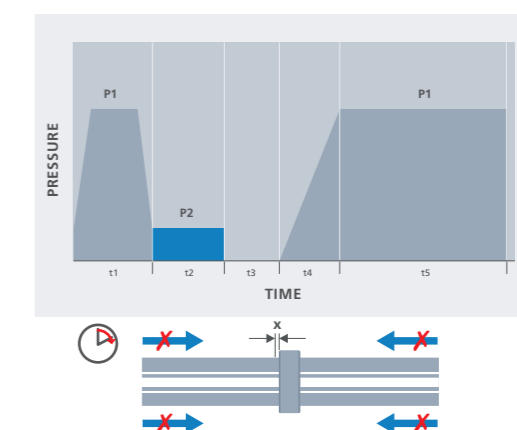
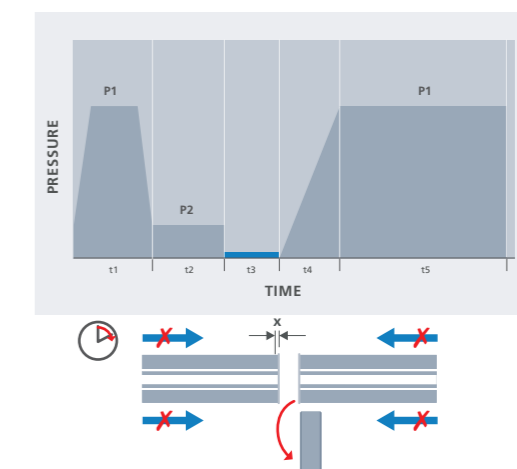

Diagram 6.13 – t3 Removing the heating element



Butt fusion welding (continued)

STEP 4 – t4

1. Immediately after completing t3, apply the relevant pressure to the machine pressure, and add the drag pressure to the force established in the pre-weld phase.
2. Once the correct pressure is reached, move to Step 5 – t5.

Diagram 6.14 – t4 Pressure increase

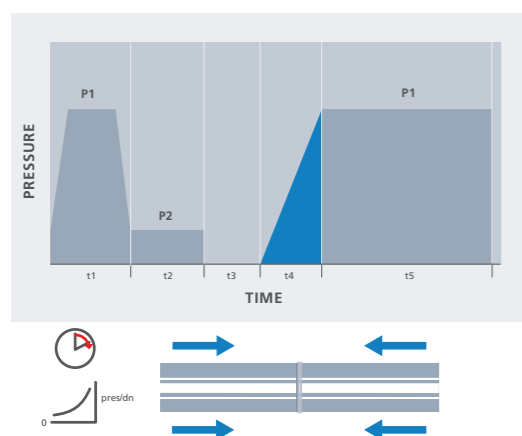

VISUAL INSPECTION

The only non-destructive method for checking weld quality is to inspect the external bead that is formed during the process. An ideal bead is shown in diagram 6.16 (below) and graph 6.17 (opposite).

Diagram 6.16

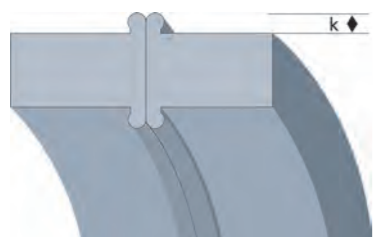

STEP 5 – t5

1. Begin time t5 and ensure that the drive bed of the machine is secured throughout the cooling period.
2. Once the t5 time is reached, release the pressure on the mating face.
3. Once the pressure on the mating faces is released, remove the welded piece from the machine.

Diagram 6.15 – t5 Cooling

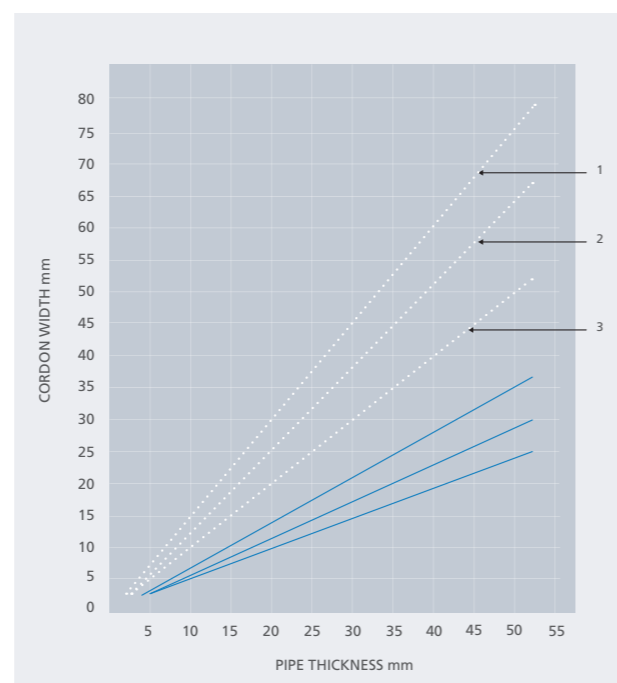
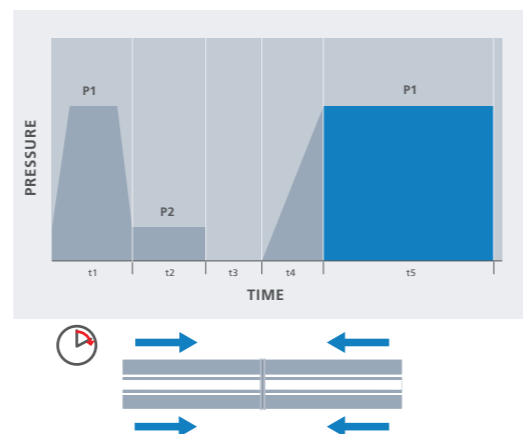

Graph 6.17

Butt fusion welding (continued)

COMMON WELD DEFECTS					
DEFECT	DESCRIPTION	EVALUATION			
		LEVEL 1	LEVEL 2	LEVEL 3	
1		Surface cracks in a parallel or transverse direction to the weld – check the weld area, the heat-affected area and the pipe surface close to the weld.	Not allowed	Not allowed	Not allowed
2		Local or continued notches in parallel to the weld with the notch root in the core material. Causes are: Incorrect pressure adjustment Too short annealing time Too short cooling time	Not allowed	Not allowed	Not allowed
3		Notches close to the weld. Caused by: Incorrect adjustment of clamping jaws Damage during transport Incorrect weld preparation	Allowed only if $\Delta s \leq 0,5 \text{ mm}$	Allowed only if $\Delta s \leq 1,0 \text{ mm}$	Allowed only if $\Delta s \leq 2,0 \text{ mm}$
4		Misalignment of pipes Machine not set up correctly	Allowed only if $e \leq 2 \text{ mm}$	Allowed only if $e \leq 4 \text{ mm}$	Allowed only if $e \leq 5 \text{ mm}$
5		Angular misalignment of pipes Machine set up incorrectly Machine failure during weld process	Allowed only if $e \leq 1 \text{ mm}$	Allowed only if $e \leq 2 \text{ mm}$	Allowed only if $e \leq 4 \text{ mm}$
6		Sharp edges on external weld bead Incorrect welding parameters Excessive weld pressure	Not allowed	Not allowed	Not allowed
7		Irregular weld bead width Check annealing time Check weld plate for temperature Check weld pressure	Allowed values are defined in the Bead width table opposite	Allowed values are defined in the Bead width table opposite	Allowed values are defined in the Bead width table opposite
8		'Dry' joint on part or all of weld bead i.e. no fusion achieved. Contaminated hot plate Hot plate out of temperature (low and high) Time t3 too long	Not allowed	Not allowed	Not allowed
9		Hollow's between the butt weld surfaces Low cooling pressure Insufficient cooling time	Not allowed	Not allowed	Not allowed
10		Contamination or gas pockets in butt weld bead Contamination during weld process Wet pipe surface during welding	Allowed isolated pores only if $\Delta s \leq 0,05s$	Allowed isolated pores only if $\Delta s \leq 0,10s$	Allowed isolated pores only if $\Delta s \leq 0,15s$

Table 6.18

Electrofusion welding

ELECTROFUSION WELDING – Ø20MM TO Ø400MM

A key feature of the MecFlow system is its CLICKWELD fittings. Electrofusion welding provides a simple, rapid method of creating a consistent weld between the spigots inserted into the electrofusion fitting, and the electrofusion fitting itself.

It's important to note that this is the only joint method by which MecFlow pipes of the same diameter, but with differing wall thicknesses, can be jointed. Both our standard MecFlow electrofusion couplings and unique CLICKWELD couplings are welded using this process.

Each coupling features a barcode label that can be read by the electrofusion machine for the purpose of set-up and weld condition data storage.

The label also contains the welding conditions that need to be set, should the electrofusion machine require a manual set-up.



Electrofusion welding (continued)

MECFLOW ELECTROFUSION COUPLINGS – Ø20MM TO Ø400MM

Equipment and set-up

There are several welding machines available that are suitable for welding MecFlow electrofusion couplings. The welding voltage for all couplings is 40V, and the welding time varies by diameter. A rotary pipe scraper is also required for de-oxidation of the pipe surface before welding.

PRE-WELDING PROCESS

1. Cut the pipe square and use a turbo scraper to de-oxidise the pipe, up to 63mm. Above 63mm orbital planers and hand planers can be used.
2. Mark the insertion depth of the coupling on both pipe surfaces to be welded.
3. Using a cotton cloth, wipe the internal surface and ends of the scraped and de-oxidised pipes.
4. Remove electrofusion couplings from packaging and insert the pipe.

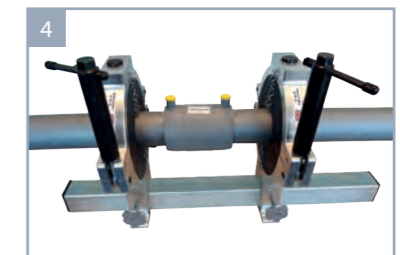

Electrofusion welding (continued)

WELDING PROCESS

The operator must be familiar with the sequence of the electrofusion welding machine before carrying out this step. Make sure the electrofusion machine is connected to a reliable and stable power source.

1. Insert the de-oxidised pipe ends into both sides of the coupling. Make sure the pipe ends are pushed fully to the coupling centre stop, and there is no angular deflection between the pipe and the coupling. Check that there is an air gap around the circumference of the coupling.
2. Tighten the supports/brackets around the pipe.
3. Connect the terminals of the welder to the electrofusion coupling.
4. Provided the machine is not showing an error, cycle the machine through the welding sequence, if available use a bar coding reader to scan the coupling.
5. Once the weld sequence has successfully completed, leave the welded coupling to cool down for the time indicated on the label. Do not disturb the coupling during the cooling period. Cooling time should be extended in ambient temperatures above 25°C, or when welding in strong direct sunlight.

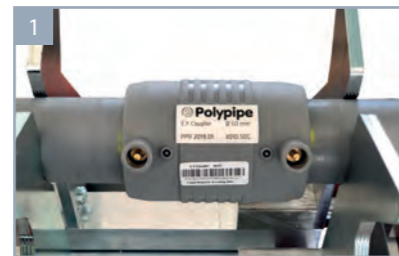

WELD QUALITY

Providing an easily-recognised reference point, our electrofusion couplings feature visual indicators, showing that the welding process has been successful. The pictures opposite show a coupling before and after welding. Providing the indicators have risen within the coupling, the weld cycle has been successful.



Pre-weld



Post-weld

Electrofusion welding (continued)

CLICKWELD FUSION COUPLINGS – Ø50MM TO Ø160MM

The CLICKWELD jointing method is different to the MecFlow electrofusion welding process, in that the electrofusion element is a spigot that is inserted into a socket of the CLICKWELD fittings.

As the CLICKWELD spigot is supplied with a cap and the socket, no special preparation is needed before beginning the welding process. When welding in-situ, the CLICKWELD spigot and fitting are held together by the patented

clipping mechanism, so supports and brackets can be tightened post-weld.

Equipment and set-up

There are several welding machines available that are suitable for welding CLICKWELD electrofusion couplings. The welding voltage for all couplings is 20V, and the welding time varies by diameter.

PRE-WELDING PROCESS



1. Remove the cap from the CLICKWELD coupling, and slide towards the intended CLICKWELD fitting.



2. Check that the spigot/socket is free of any mechanical damage or defects, and insert the spigot into the socket, clicking the clips of the CLICKWELD coupling into the grooves of the fitting.

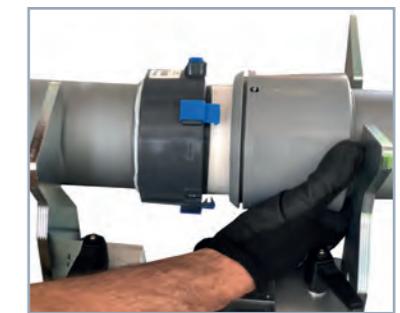

3. Check that the joint has no angular deflection – adjust the containment accordingly.

Electrofusion welding (continued)

WELDING PROCESS

The operator must be familiar with the sequence of the electrofusion welding machine before carrying out this step. Make sure the electrofusion machine is connected to a reliable and stable power source.

1. Check that all clips are fully engaged and that there is an air gap around the circumference of the CLICKWELD joint.
2. Connect the terminals of the welder to the electrofusion coupling.
3. Provided the machine is not showing an error, cycle the machine through the welding sequence. If available use a bar coding reader to scan the coupling.
4. Once the weld sequence has successfully completed, leave the welded coupling to cool down for the time indicated on the label. Do not disturb the coupling during the cooling period. Cooling time should be extended in ambient temperatures above 25°C, or when welding in strong direct sunlight.

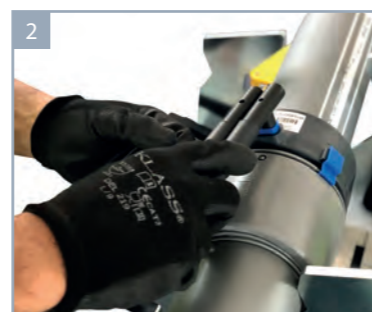
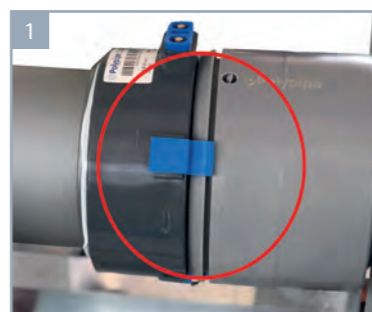

Mechanical jointing

FLANGED CONNECTIONS – Ø40MM TO Ø400MM

Flanged connections are available in the MecFlow range with the following weld connections:

- Socket fusion welding – Ø40mm up to Ø125mm
- Butt fusion welding – Ø160mm up to Ø400mm
- CLICKWELD – Ø75mm up to Ø160mm

Care must be taken to tighten flanged connections evenly during installation.

THREADED CONNECTIONS – Ø20mm x ½" BSP to Ø110mm x 4" BSP

Threaded connections are available in BSPM and BSPF thread types. Appropriate welding methods are listed below:

- Socket fusion threaded connections – Ø20mm to ½" up to Ø110mm to 4"
- CLICKWELD connections – Ø50 to 1 ½" up to Ø110mm to 4"

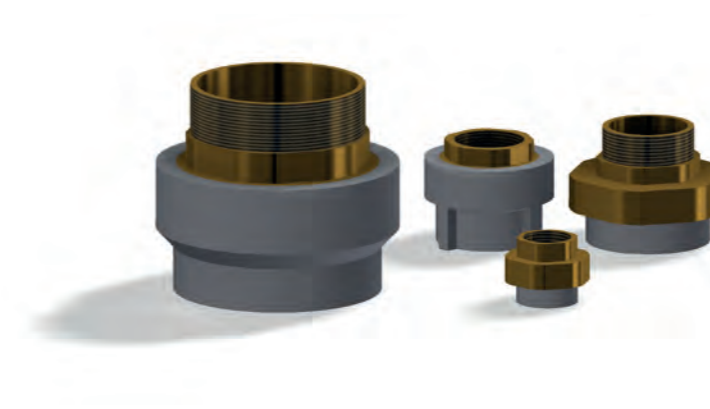

7. Installation

It's vital that the MecFlow system is installed correctly to maximise its performance over its service life.

The following installation methods are engineered to support the system performance over a number of applications. For niche applications, we recommend that you contact the Polypipe Advantage team on 01622 795200.

PIPE WEIGHTS

Pipe weights and filled pipe weights are shown in the table below.

PIPE WEIGHTS		
PIPE Ø	PIPE WEIGHT/m (kg)	PIPE + Water/m (kg)
20	0.14	0.30
25	0.21	0.47
32	0.35	0.78
40	0.39	1.23
50	0.60	1.92
63	0.96	3.05
75	1.36	4.32
90	1.96	6.22
110	2.92	9.28
125	3.77	11.99
160	6.1	19.64
200	9.66	30.69
250	15.09	47.96
315	23.96	76.14
400	38.64	122.77

Table 7.01

SYSTEM BRACKETING – GENERAL

- The brackets used to install the MecFlow system must be capable of supporting the pipe weights as shown in Table 7.01.
- Brackets must be rubber lined to prevent the pipe surface from being dented or damaged by the bracket ring. For noise-sensitive operations the use of isophonic brackets is recommended.
- Guide brackets and anchor brackets should be placed on the system in accordance with 7.03 and 7.04.
- Guide brackets – Guide brackets must control the axial movement of the pipe in the direction of the applied thermal movement forces.
- Anchor brackets – Anchor brackets lock the pipe into position, and should be robust enough to counteract any thrust forces applied to the pipe due to thermal movement.
- MecFlow isophonic brackets are designed to be dual configured as guide and anchor brackets with the use of removable spacers.

Diagram 7.02

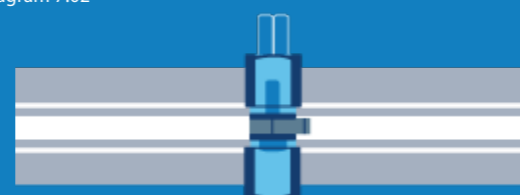

MecFlow bracket without spacer (anchors and guides)



MecFlow bracket with spacer (anchor)

System bracketing

Brackets should be connected to the substrate using threaded rod or another sufficient containment method (see diagram 7.02). If threaded rod is used, the rod length should be kept to a minimum to prevent the bracket fixing from bending or swinging when the system is in operation.

BRACKET DISTANCES – GENERAL

HORIZONTAL BRACKET DISTANCES						
PIPE OD cm	20°	50°	70°	20°	50°	70°
	cm	cm	cm	cm	cm	cm
20	90	85	70			
25	105	95	80			
32	120	110	95			
40				125	115	100
50				145	135	120
63				165	155	135
75				175	160	140
90				185	170	145
110				200	170	150
125				205	175	155
160				210	180	160
200				220	190	170
250				225	200	175
315				230	205	185
400				210	220	195
500						

Table 7.03

VERTICAL BRACKET DISTANCES						
PIPE OD cm	20°	50°	70°	20°	50°	70°
	cm	cm	cm	cm	cm	cm
20	117	111	91			
25	137	124	104			
32	156	143	124			
40				163	150	130
50				189	176	156
63				215	202	176
75				228	208	182
90				241	221	189
110				260	221	195
125				267	228	202
160				273	234	208
200				286	247	221
250				293	260	228
315				299	267	241
400				325	286	254
500						

Table 7.04

Thermal movement

CONTROL OF THERMAL MOVEMENT

Due to the microfibre additive featured in the MecFlow system, expansion and contraction due to temperature change is significantly reduced. However, it is still important to control thermal movement to counteract the forces generated.

This can be achieved using various installation techniques and a combination of anchor and guide brackets.

MecFlow coefficient of thermal expansion: 0.04mm/m.°C

The general equation for calculating thermal movement in a system (or part of a system) is listed below.

Equation 1

$$\Delta L = L \times \lambda \times \Delta t$$

ΔL = Calculated thermal movement

L = Length

λ = Coefficient of thermal expansion for MecFlow

Δt = Expected temperature difference

The value for ' Δt ' should be taken as the difference between the ambient temperature at the time of system installation and the fluid temperature once the system is operating.

As the pipe must generally be at the ambient temperature prior to commissioning, ambient temperature should not be taken into account during the operation of the system.

Worked Example

Calculate the thermal movement seen in the pipe below.

System pipe length = 6m

Temperature difference = 20°C

$L = 6\text{m}$, $\Delta t = 20^\circ\text{C}$, $\lambda = 0.04\text{mm/m/}^\circ\text{C}$

$\Delta L = L \times \lambda \times \Delta t$

$\Delta L = 6 \times 0.04 \times 20$

$\Delta L = 4.8\text{mm}$

The table below shows the rate of thermal movement by pipe length for a given change in temperature.

LENGTH (L)	Δt								
	1°	10°	20°	30°	40°	50°	60°	70°	80°
	LINEAR EXPANSION mm								
1m	0.0	0.4	0.8	1.2	1.6	2.0	2.4	2.8	3.2
3m	0.1	1.2	2.4	3.6	4.8	6.0	7.2	8.4	9.6
5m	0.2	2.0	4.0	6.0	8.0	10.0	12.0	14.0	16.0
10m	0.4	4.0	8.0	12.0	16.0	20.0	24.0	28.0	32.0
15m	0.6	6.0	12.0	18.0	24.0	30.0	36.0	42.0	48.0
20m	0.8	8.0	16.0	24.0	32.0	40.0	48.0	56.0	64.0
25m	1.0	10.0	20.0	30.0	40.0	50.0	60.0	70.0	80.0
30m	1.2	12.0	24.0	36.0	48.0	60.0	72.0	84.0	96.0
35m	1.4	14.0	28.0	42.0	56.0	70.0	84.0	98.0	112.0
40m	1.6	16.0	32.0	48.0	64.0	80.0	96.0	112.0	128.0
45m	1.8	18.0	36.0	54.0	72.0	90.0	108.0	126.0	144.0
50m	2.0	20.0	40.0	60.0	80.0	100.0	120.0	140.0	160.0

Table 7.05

THERMAL MOVEMENT – CONTROL METHODS

The following methods provide thermal movement control for the MecFlow system.

- Deflection leg
- Expansion loop
- Pre-stressing
- Sliding tee's
- Fully locked (anchored)

DEFLECTION LEG

Deflection leg control is where a bend in the system is allowed to 'flex' in a controlled manner, so as to allow for thermal movement (see diagram 7.06).

If this method is used it is essential to place anchor brackets at distances ' L ' and ' L_b ' from the bend point. Distance ' L_b ' must be calculated to take into account the distance ' L ', the pipe diameter, and the system temperature conditions.

Diagram 7.06

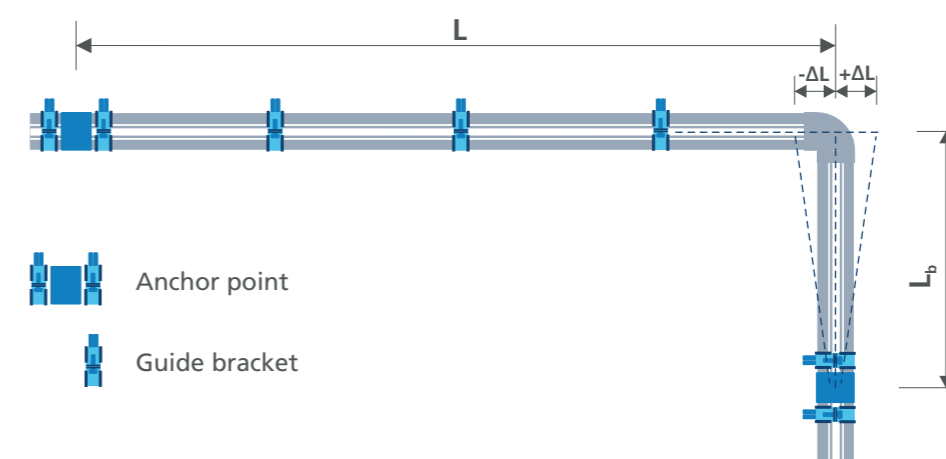

The equation to calculate distance ' L_b ' is given as:

Equation 2

$$L_b = \lambda \times \sqrt{d \times \Delta L}$$

λ = MecFlow coefficient of thermal movement

d = Outside diameter of pipework

ΔL = Calculated thermal movement for distance L

Thermal movement (continued)

The table below indicates the distance 'L_b' for a given thermal movement by pipe diameter.

PIPE OD mm	LINEAR EXPANSION mm											
	10	20	30	40	50	60	70	80	90	100	110	120
20	0.57	0.80	0.98	1.13	1.26	1.39	1.50	1.60	1.70	1.79	1.88	1.96
25	0.63	0.89	1.10	1.26	1.41	1.55	1.67	1.79	1.90	2.00	2.10	2.19
32	0.72	1.01	1.24	1.43	1.60	1.75	1.89	2.02	2.15	2.26	2.37	2.48
40	0.80	1.13	1.39	1.60	1.79	1.96	2.12	2.26	2.40	2.53	2.65	2.77
50	0.89	1.26	1.55	1.79	2.00	2.19	2.37	2.53	2.68	2.83	2.97	3.10
63	1.00	1.42	1.74	2.01	2.24	2.46	2.66	2.84	3.01	3.17	3.33	3.48
75	1.10	1.55	1.90	2.19	2.45	2.68	2.90	3.10	3.29	3.46	3.63	3.79
90	1.20	1.70	2.08	2.40	2.68	2.94	3.17	3.39	3.60	3.79	3.98	4.16
110	1.33	1.88	2.30	2.65	2.97	3.25	3.51	3.75	3.98	4.20	4.40	4.60
125	1.41	2.00	2.45	2.83	3.16	3.46	3.74	4.00	4.24	4.47	4.69	4.90
160	1.60	2.26	2.77	3.20	3.58	3.92	4.23	4.53	4.80	5.06	5.31	5.54
200	1.79	2.53	3.10	3.58	4.00	4.38	4.73	5.06	5.37	5.66	5.93	6.20

Note: Linear expansion is calculated using equation 1 for the distance 'L'

Table 7.07

EXPANSION LOOPS

Expansion loop control is where a loop in the system is allowed to 'flex' in a controlled manner, allowing thermal movement (see diagram 7.08). If this method is used it is essential to place anchor brackets at distances 'L' and 'L_b' from the bend point. Distance 'L_b' must be calculated, take into account the distance 'L', the pipe diameter, and the system temperature conditions.

'L_b' should be calculated in accordance with equation 2.

'L₂' should be calculated using equation 3; the minimum 'L₂' value is 210mm.

Table 7.07 above, gives the distance 'L_b' for a given thermal movement by pipe diameter.

Equation 3

$$L_{2min} = 2 \times \Delta L \times SD$$

ΔL = Calculated thermal movement for distance L

SD = Safety distance = 150mm

Diagram 7.08

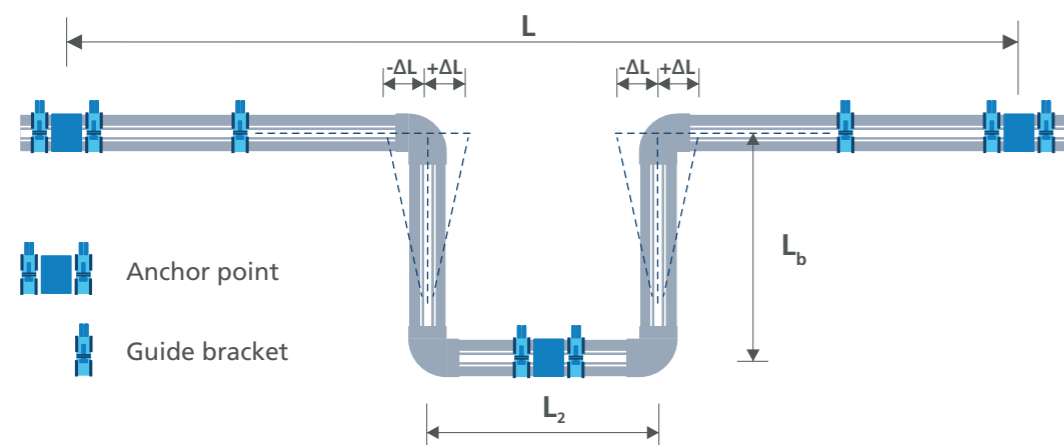

PRE-STRESSING

The pre-stressing method is useful in instances where space is limited, and the distance 'L_b' for either the deflection leg or expansion loop method needs to be kept to a minimum.

The system is installed with pre-stressed elements in the opposite direction to the intended thermal movement, ensuring that when the system is commissioned thermal movement is limited, or in certain cases is eliminated.

For both deflection legs and expansion loops the distance 'L_{bps}' is calculated using equation 4.

Equation 4

$$L_b = \lambda \times \sqrt{\frac{\Delta L}{2}}$$

The distance 'L₂' is calculated as per standard expansion loops using equation 3. Again, the minimum distance is 150mm.

Diagram 7.09

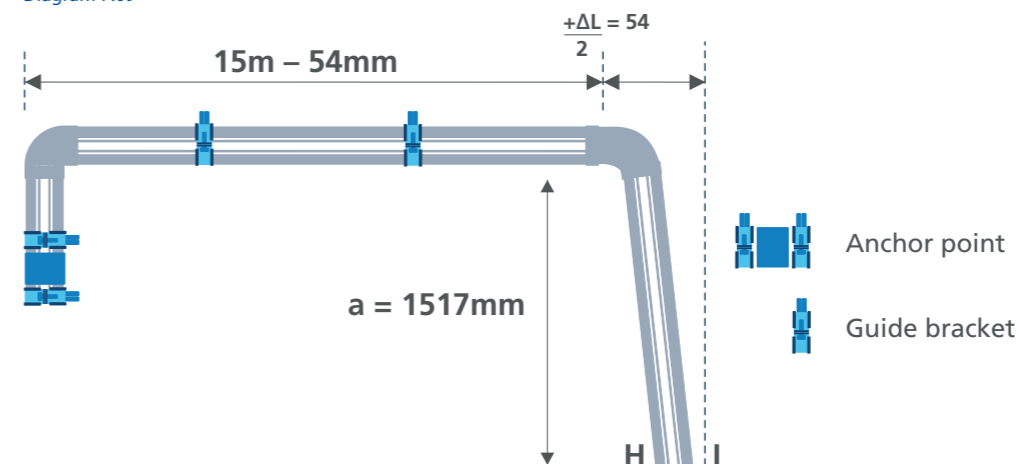
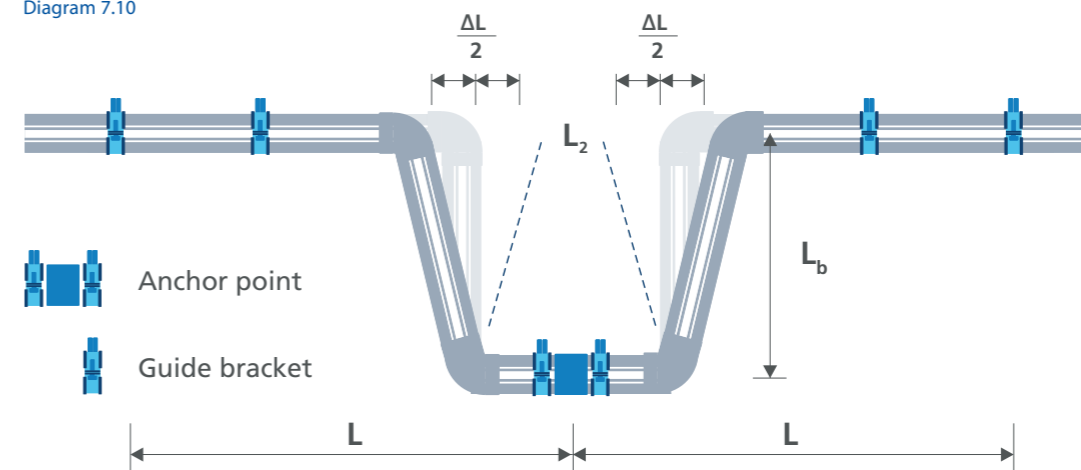

Diagram 7.10



Thermal movement (continued)

The table below indicates the distance 'L_{bps}' for a given thermal movement by pipe diameter.

PIPE OD mm	LINEAR EXPANSION mm											
	10	20	30	40	50	60	70	80	90	100	110	120
	L _{bps} mmw											
20	0.40	0.57	0.69	0.80	0.89	0.98	1.06	1.13	1.20	1.26	1.33	1.39
25	0.45	0.63	0.77	0.89	1.00	1.10	1.18	1.26	1.34	1.41	1.48	1.55
32	0.51	0.72	0.88	1.01	1.13	1.24	1.34	1.43	1.52	1.60	1.68	1.75
40	0.57	0.80	0.98	1.13	1.26	1.39	1.50	1.60	1.70	1.79	1.88	1.96
50	0.63	0.89	1.10	1.26	1.41	1.55	1.67	1.79	1.90	2.00	2.10	2.19
63	0.71	1.00	1.23	1.42	1.59	1.74	1.88	2.01	2.13	2.24	2.35	2.46
75	0.77	1.10	1.34	1.55	1.73	1.90	2.05	2.19	2.32	2.45	2.57	2.68
90	0.85	1.20	1.47	1.70	1.90	2.08	2.24	2.40	2.55	2.68	2.81	2.94
110	0.94	1.33	1.62	1.88	2.10	2.30	2.48	2.65	2.81	2.97	3.11	3.25
125	1.00	1.41	1.73	2.00	2.24	2.45	2.65	2.83	3.00	3.16	3.32	3.46
160	1.13	1.60	1.96	2.26	2.53	2.77	2.99	3.20	3.39	3.58	3.75	3.92
200	1.26	1.79	2.19	2.53	2.83	3.10	3.35	3.58	3.79	4.00	4.20	4.38

Note: Linear expansion is calculated using equation 1 for the distance 'L'.

Table 7.11

SLIDING T

The Sliding T is a similar method to the deflection leg for controlling thermal movement. The distance 'L' is used to determine the thermal movement to be controlled using equation 1, and the distance 'L_b' is determined using equation 2. This method cannot be configured as a pre-stressed solution.

Diagram 7.12 indicates the distance 'L_b' for a given thermal movement by pipe diameter.

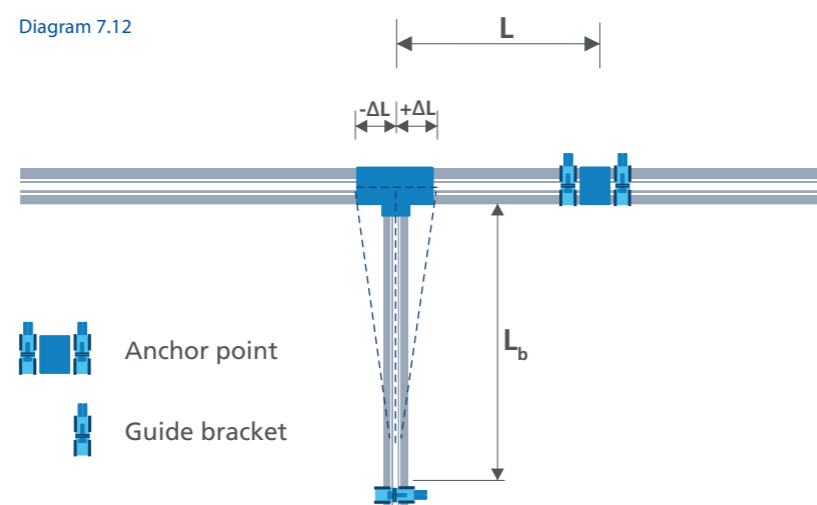

Compensating for changes in length using an expansion leg, 'L_b'

FULLY LOCKED SYSTEM

The fully locked system is ideal for BCWS and CWS service risers as there is minimal thermal movement to control. The fully locked system relies on anchor points placed at each floor level of the riser which effectively 'locks' the axial thermal movement of the system. As the system is locked there is no movement acting on any branches in the section of riser between the two anchor points.

The maximum distance between two anchor points is 3 metres. Guidance on how to create an anchor point is given in diagram 7.13. Anchor brackets should be close coupled to the supporting substrate, and if threaded rod is being used it must be capable of supporting the bracket in position. As a rule of thumb, rod size should be at least M10 for sizes up to 160mm, and M16 for sizes above 160mm.

Guide brackets are also required to support the pipe, and these distances can be referenced in table 7.04 – vertical bracket distances.

Diagram 7.13

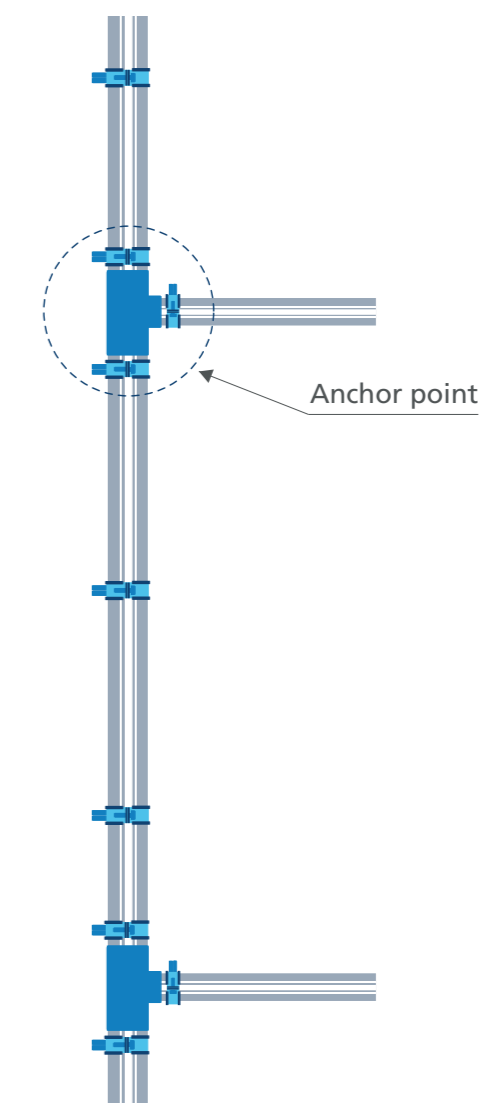

Thermal movement (continued)

ANCHOR POINTS

Diagram 7.14 below shows how to create a horizontal/vertical anchor point.

Diagram 7.14

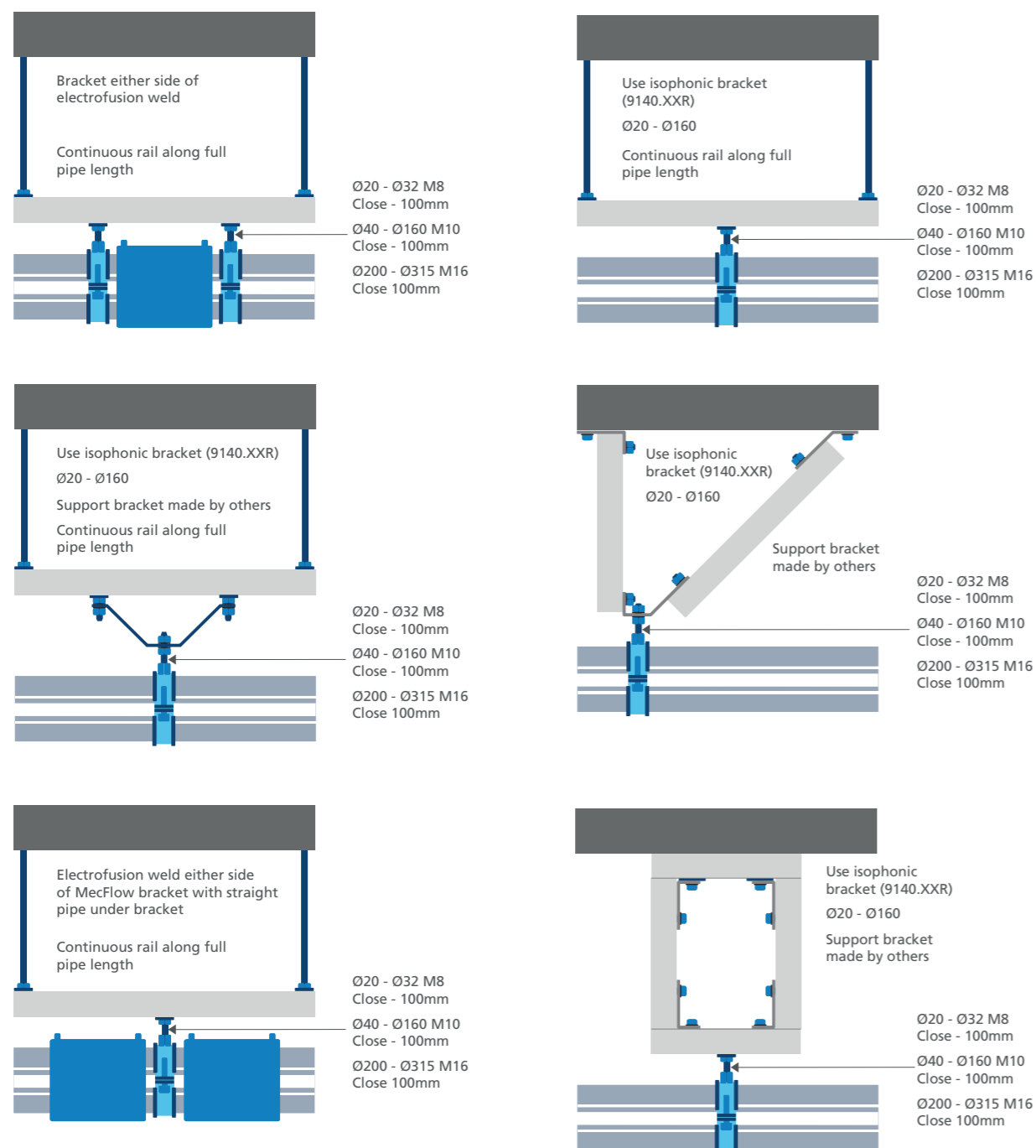

COMPENSATORS

Standard, 'off-the-shelf' compensators must not be used within the MecFlow system. If a different method of expansion control is needed, please contact the Polypipe Advantage team for technical guidance on 01622 795200.

FLOOR/WALL PENETRATIONS

In instances where MecFlow pipes penetrate floors and walls, care must be taken to protect the surface of the pipe from any mechanical damage. This is achieved by sleeving the pipe with protection (insulation material) throughout the penetration. For fire rated compartments see the section on fire compartmentation.

Diagram 7.15

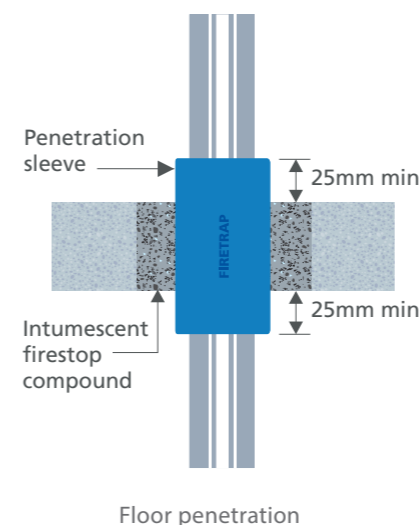

BUILDING EXPANSION JOINTS

Where the MecFlow system crosses building expansion joints, care must be taken to protect the system from excessive building movement. There are several installation solutions available, and the Polypipe Advantage team are on hand to offer technical guidance and identify the best solution for your project; dependent on the direction and extent of the thermal movement.

Diagram 7.16

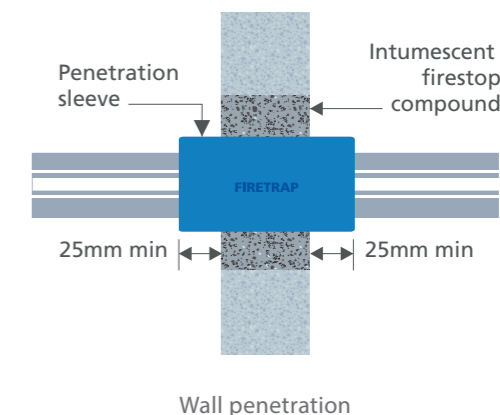

TRACE HEATING/HEAT TAPE

Both trace heating and heat tapes can be used on MecFlow systems. The products used must be checked with the manufacturer as being suitable for plastic pipe, and the surface temperature of the MecFlow system must not exceed 70°C at any point. Care must be taken in both the design and installation of these external heat sources.

Thermal movement (continued)

FIRE COMPARTMENTATION

Although the MecFlow system has an excellent fire rating classification, the system must be considered as combustible for the purposes of compliance to UK Building Regulation B. With this in mind, where MecFlow pipes of nominal diameter $\geq \text{Ø}40\text{mm}$ pass through a fire compartment floor or wall, the penetration must be protected with a fire sleeve.



Our Firetrap Sleeves have been tested with MecFlow to BS EN 1366-3. For a copy of the test report and further technical guidance, please contact the Polypipe Advantage team on 01622 795200.

Diagram 7.17



INSULATION

The MecFlow system is compatible with all common pipe insulation materials. Insulation thickness should be selected in accordance with Building Regulations, design standards and industry guides, such as the Domestic Heating Compliance Guide and the TIMSA Guidance for Achieving Compliance with Part L of the Building Regulations.

CONNECTION TO OTHER MATERIALS

Connection to other materials can be achieved using the MecFlow range of threaded fittings, and for larger diameters, flanged connections. Thread forms are manufactured to:

Threaded Connections

BS EN 10226-1:2004 – Pipe threads where pressure tight joints are made on the threads. Taper external threads and parallel internal threads. Dimensions, tolerances and designation.

Unions

BS EN ISO 228-1:2003 – Pipe threads where pressure-tight joints are not made on the threads. Dimensions, tolerances and designation.

MECFLOW CONNECTED TO COPPER SYSTEMS

Under certain conditions, by-products of copper in water systems can cause a reaction in the MecFlow material. For MecFlow pipes where copper is present in heating circuits at 70°C, the following max pressures and velocities shown in Table 7.18, should be observed.

Although brass is an alloy of copper and zinc, there is little risk of significant oxidation in threaded brass fittings, therefore these can be discounted from the above.

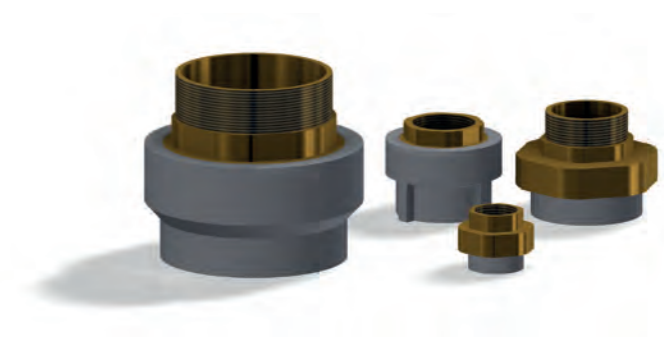

MAXIMUM WATER TEMPERATURE	VELOCITY		MAXIMUM WATER VELOCITY
	20-32mm	40-250mm	
70°C	14 bar	9 bar	1.50m/s

Table 7.18

8. System commissioning & Maintenance

The purpose of system commissioning is to test that the system as installed is leak-free, clear of impurities and – where required – is disinfected before being placed into service. In the UK there are several guidance documents that detail how to test and flush the system, which include (but aren't limited to):

- BS EN 806-4:2010 – Specifications for installations inside buildings conveying water for human consumption.
- BS 8558:2015 Guide to the design, installation, testing and maintenance of services supplying water for domestic use within buildings and their curtilages. Complementary guidance to BS EN 806
- WRAS Water Regulations Guide.
- The Control of Legionella in Water Systems – Approved Code of Practice L8.
- Guidance on which systems require disinfection prior to commissioning is also detailed in the aforementioned documents.

HYDROSTATIC PRESSURE TESTING

The MecFlow system should be tested as a plastic system as described in the above guidance documents. There are two test methods, Test A and Test B (graphs 8.01 & 8.02), prescribed for the testing of plastic systems. Either of these methods are suitable for MecFlow.

Although the MecFlow system can comfortably be tested at 1.5 times its nominal pressure rating, care should be taken to check that all components, supplied by others, installed in the MecFlow system are able to withstand the applied test pressure. Once the hydrostatic pressure test is completed, the result should be recorded and documented as per the client's requirement.

Water tightness procedure - Test A

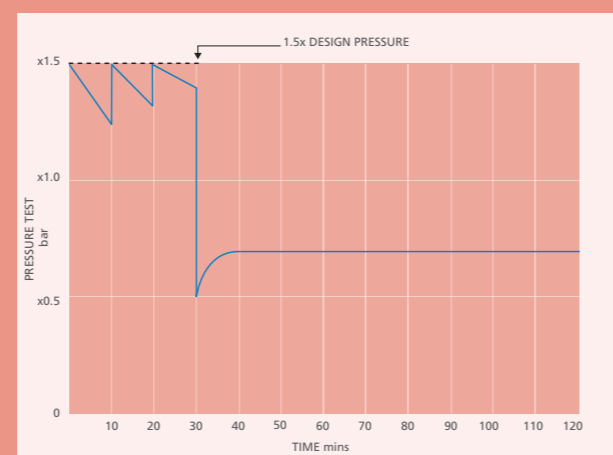

Graph 8.01

Water tightness procedure – Test B

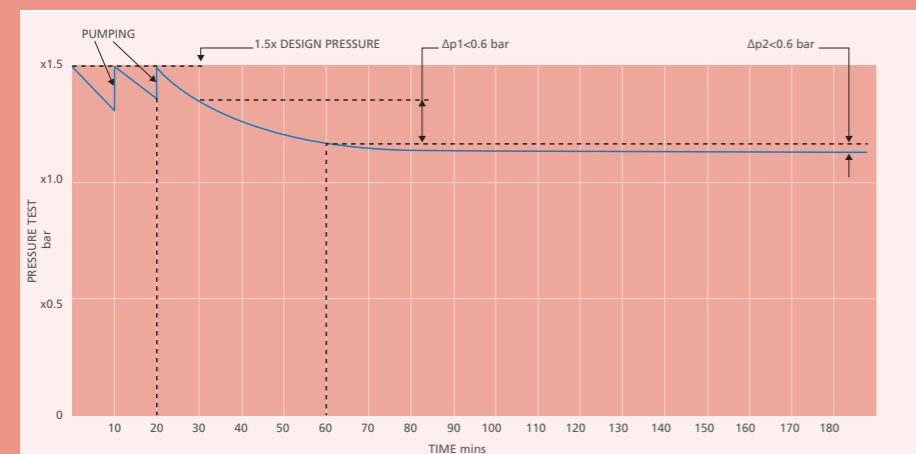

Graph 8.02

System commissioning – general

TESTING WITH AIR

It is not recommended to site test the MecFlow system using compressed air.

SYSTEM REPAIR

If a leak is discovered in the MecFlow system during testing there are two methods of repair available.

1. 'Cutting in' using electrofusion couplings as slip couplings.
2. Using a PP-r plug repair kit.

Cutting in a new section of MecFlow using electrofusion couplings

1. Drain the system completely before cutting out the repair section.
2. Measure and mark the section(s) to be cut out.
3. Cut out the section for repair. Make sure the cuts are square.
4. Ensure the cut pipe ends are dry. Mark the EF coupling insertion depth.
5. De-oxidise the pipe ends ready for welding.
6. Prepare the repair piece and de-oxidise the pipe ends.
7. Slip the electrofusion couplings onto the repair piece.
8. Offer the repair piece up to the job and slip the couplings onto the system.
9. Line the couplings up to the insertion depth marks on both sides.
10. Ensure there is no external stress on the system and/or couplings.
11. Go through the welding process as described in Jointing Methods, Section 6.
12. The system can be re-tested once the EF couplings have completed their cooling time.

Diagram 8.03

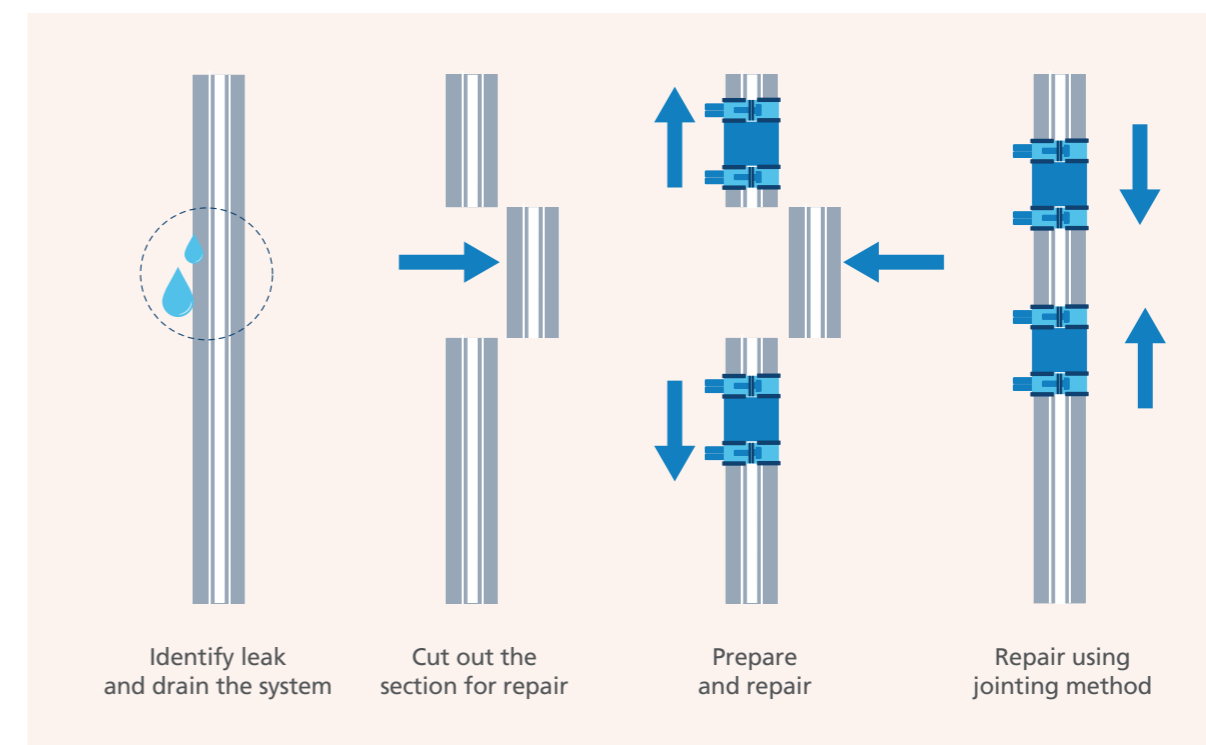

System commissioning & Maintenance – general (continued)

PLUGGING USING REPAIR KIT

1. Drain the system section to be repaired completely. Drill the hole to be repaired with an M8 drill bit – ensure that the hole is at 90° to the pipe.
2. Using the repair iron, heat the hole surface and repair plug at the same time for 15 seconds.
3. Remove the iron from the hole and insert the repair plug immediately.
4. Hold plug in place for 1 minute.
5. Cut off any remaining protrusion of the repair plug.
6. The joint shall be ready for testing after 5 minutes.

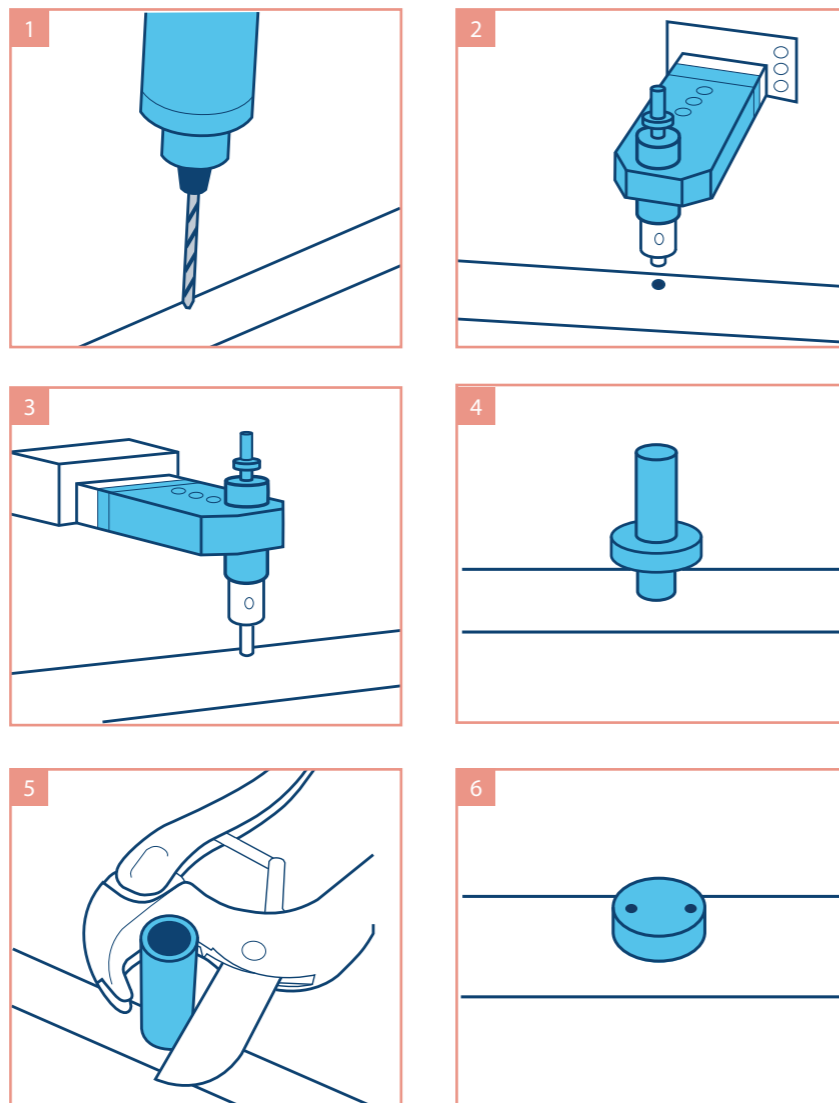

SYSTEM FLUSHING

Once the hydrostatic test has been successfully completed the system should be flushed with drinking water immediately before commissioning. Flushing should be carried out in accordance with the aforementioned guidance documents. If the system is not placed in service after testing and flushing, it should be flushed according to procedures at regular intervals.

CHEMICAL DISINFECTION

Where a MecFlow system needs to be disinfected before being brought into service, the methods described in the previously mentioned guidance documents must be strictly adhered to.

Care must be taken to select the correct disinfectant, ensure that the dilution is controlled, ensure the level of disinfectant over a given contact period is observed, that samples are taken at the correct points to assess the efficiency of the disinfection, and finally that the system is thoroughly flushed through after the disinfection to remove the disinfectant before the system is put into service.

THERMAL DISINFECTION

MecFlow can withstand thermal disinfection process $\leq 70^{\circ}\text{C}$.

SHOCK CHEMICAL DISINFECTION

Although the MecFlow system does not promote bacterial growth, it is possible that it may be installed in a system that, under certain circumstances, could require disinfection during its service life – either as part of a maintenance regime or because the level of bacterial growth in the total system presents a hazard.

In this instance, the total system may require shock disinfection. Documents such as 'The Control of Legionella in Water Systems – Approved Code of Practice L8' provide guidance on methods of shock disinfection, and these must be rigidly adhered to. If there is any doubt about the method, chemical, temperature or contact period prescribed in the above, or any other guidance document, then please contact the Polypipe Advantage team on 01622 795200 for further technical advice.

CHLORINE DIOXIDE

The use of chlorine dioxide as a disinfectant is permitted however the level of constant dosing must be strictly controlled and shall not exceed 0.5mg/l. Guidance as to the use of this chemical as a disinfectant is provided in BS EN 806 and the addendum BS 8558:2015. Further guidance is provided in ACoP L8.

9. Approvals

Quality Management System

The MecFlow range is manufactured under a strict Quality Management System (QMS). The MecFlow QMS is periodically third party audited and certified to ISO 9001 Quality Management.

The system requires demonstrated compliance to:

- Organisational competence, training and documentation.
- QA measurement and test equipment – periodic calibration and documentation.
- Inspection and measurement of input raw material and documentation.
- Process control documentation and recording of process conditions.
- Inspection and measurement of finished product and documentation.
- Treatment, storage and handling of finished product and documentation.
- Product marking and traceability.
- Treatment of non-conforming material/product, corrective action and documentation.
- New product design and change of product design process, recording and documentation.

Contact the Polypipe Advantage team on 01622 795200 for a certificate or more information on our ISO9001 Quality Management System.



Quality assurance

To underpin the QMS, the MecFlow product is checked several times during its manufacture and testing.

RAW MATERIAL INPUT

Before any raw materials enter the manufacturing facility, checks are made to affirm that they conform with the relevant manufacturing standards. Tolerances are provided to be measured against, and any materials which are out of tolerance are rejected.

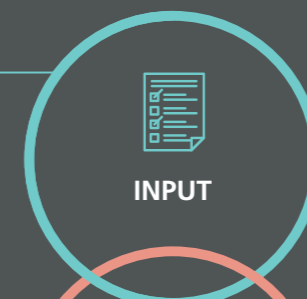

FORMULATION

MATERIAL FORMULATION

Once the raw material is accepted into the manufacturing facility, the required materials recipe is formulated in the mixing plant. Post-mixing, the material is tested for its mechanical and processing characteristics. Any out of tolerance material is assessed and, where possible, re-worked into other non-pressure products.



PRODUCT MANUFACTURE

During manufacture, products are periodically checked for dimensional stability and processing conditions are logged. Any non-conforming products are assessed and, where possible, re-worked into other non-pressure products.

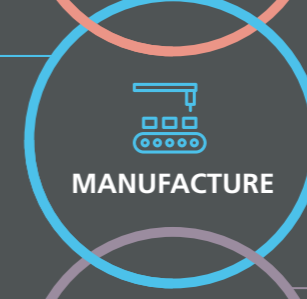

POST PRODUCTION

POST PRODUCTION TESTS

Post manufacture the products are subjected to several individual checks to assess:

- Dimensions
- Finished appearance
- Material homogeneity
- Hydrostatic pressure resistance
- Mechanical behaviour
- Tensile strength
- Material resistance to elevated temperature

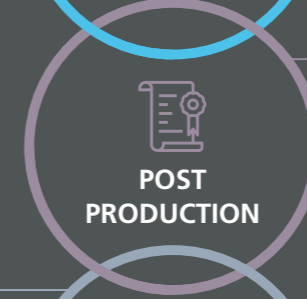

POLYPIPE ADVANTAGE

The Polypipe Advantage team is on-hand to provide support and system design to deliver an end-to-end water supply solution. They'll create a system that's specific to your project, and all under factory-controlled conditions within our state-of-the-art fabrication facility. Your Kit will then be delivered to site, ready for installation.

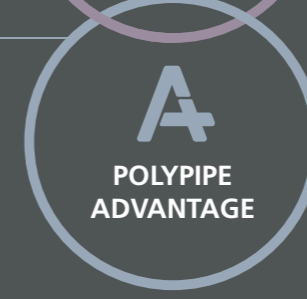

- Designed using BIM technology, in line with ISO 15874 standards
- Fabricated, tested and fully inspected under factory-controlled conditions
- Delivered to site as a ready-to-install Kit
- Delivered in accordance with FORS Silver – when transported directly from Polypipe

Any test failure will result in further checks to the manufacturing batch. All failed product batches will be assessed for suitability for recycling back into a non-pressure production process.

Manufacturing standards

The MecFlow system is made to the manufacturing standards stated below. These standards set out the dimensional, physical and mechanical characteristics that each individual product shall conform to.

ISO 15874 Plastics piping systems for hot and cold water installations – Polypropylene (PP)

- Part 1 – General
- Part 2 – Pipes
- Part 3 – Fittings
- Part 5 – Fitness for purpose of the system
- Part 7 – Guidance for assessment of conformity

DIN 8077 Polypropylene (PP) pipes - PP-H, PP-B, PP-R, PP-RCT – Dimensions.

DIN 8078 Polypropylene (PP) pipes - PP-H, PP-B, PP-R, PP-RCT – General Quality Requirements & Testing.

NTC 4897-2 Systems of plastic pipes for hot and cold water – Polypropylene (PP).

RP 01.00 Common requirements for AENOR Certification of Plastic Products.

RP 01.78 Special regulations of the Certificate of Conformity AENOR for Piping Systems in random polypropylene with modified crystalline structure (PP-RCT) and fiberglass (FV) for hot and cold water installations inside the structure of the Buildings.

BS EN ISO 1043-1:2011+A1:2016 Plastics. Symbols and abbreviated terms. Basic polymers and their special characteristics.

ISO 9080:2003 Plastics piping and ducting systems – Determination of the long-term hydrostatic strength of thermoplastics materials in pipe form by extrapolation.

BS EN ISO 7686:2005 Plastic pipes and fittings. Determination of opacity.



WRAS CERTIFICATION

The MecFlow system has both WRAS material and WRAS product approval. For a copy of the certificates, please contact Polypipe Advantage team on 01622 795200 or email mecflow@polypipe.com.

FIRE COMPARTMENTALISATION

MecFlow has been 3rd Party tested with Polypipe Firetrap Sleeves (passive fire protection products) to achieve a 2-hour insulation and integrity compartment rating. Testing was performed at Exova, Warrington, and a test certificate can be requested through Polypipe Advantage team on 01622 795200 or email mecflow@polypipe.com.

FIRE CLASSIFICATION

The MecFlow system has been 3rd party tested to the standard stated below and achieved a classification of B-s1, d0. This is the highest classification that an organic material can obtain. The test was performed by AIFITI, Madrid, and a test certificate can be requested through Polypipe Advantage team on 01622 795200 or email mecflow@polypipe.com.

BS EN 13501-1@2018 Fire classification of construction products and building elements. Classification using data from reaction to fire tests.



WRAS 1907063 – MecFlow Pipe and Fittings



10. Technical specification

System description

The MecFlow system shall be as indicated on the drawings, manufactured in accordance with ISO 9001 and delivered within the agreed programme of works.

The product shall be designed and delivered as a fabricated solution in accordance with site specific design criteria with welds pre-tested during the manufacturing process.

The system shall be manufactured using multi-layer pipe technology made from reinforced Polypropylene, suitable for use in the following applications:

1. Boosted Cold Water
2. LPHW / LTHW
3. Chilled Water
4. Heating

The MecFlow product shall be suitable for water temperatures up to 95°C. Operating pressures vary dependant on fluid temperatures, as displayed in the Working Pressures table within the MecFlow Technical Manual.

Pipework joints and connections are to be made utilising patented CLICKWELD electrofusion jointing methods, providing a homogenous weld. Where CLICKWELD fittings are not provided, joints shall be made utilising MecFlow electrofusion couplings.

The CLICKWELD jointing method shall permit the installation to be carried out, without the requirement to clamp pipework in place prior to the jointing procedures being carried out.

The MecFlow CLICKWELD and electrofusion-coupling jointing procedure shall be able to be carried out utilising one electrofusion coupling machine.

TEMPERATURE	YEARS OF SERVICE	MECFLOW DIAMETERS 20 - 32mm		MECFLOW DIAMETERS 40 - 400mm WALL THICKNESS 10mm	
		BAR	PSI	BAR	PSI
10°C	1	39.20	568.52	25.08	363.75
	5	38.20	554.04	24.40	353.89
	10	37.57	544.90	24.04	348.67
	25	36.75	533.01	23.52	341.12
	50	36.50	529.38	23.36	338.80
20°C	1	34.15	495.30	21.85	316.90
	5	33.05	479.34	21.15	306.75
	10	32.77	474.70	20.97	304.14
	25	32.00	464.12	20.48	297.03
	50	31.70	459.76	20.30	294.42
30°C	1	29.80	432.21	19.08	276.73
	5	29.00	420.60	18.56	269.19
	10	28.45	412.63	18.20	263.96
	25	27.90	404.65	17.85	258.89
	50	27.62	400.59	17.68	256.42
40°C	1	26.05	377.82	16.67	241.77
	5	25.20	365.49	16.12	233.80
	10	24.65	357.51	15.77	228.72
	25	24.37	353.45	15.60	226.25
	50	23.82	345.47	15.24	221.03
50°C	1	23.52	341.12	15.05	218.28
	5	23.05	334.31	14.75	213.93
	10	22.17	321.54	14.19	205.80
	25	21.60	313.28	13.82	200.44
	50	21.30	308.93	13.63	197.78
60°C	1	20.75	300.95	13.20	191.44
	5	20.45	296.60	13.00	188.54
	10	19.37	280.93	12.40	179.84
	25	18.80	272.67	12.03	174.48
	50	18.50	268.31	11.84	171.72
70°C	1	17.92	259.90	11.47	166.35
	5	17.70	256.71	11.30	163.89
	10	16.55	240.03	10.59	153.59
	25	15.67	227.27	10.00	145.03
	50	15.40	223.35	9.85	142.86
80°C	1	15.10	219.00	9.66	140.10
	5	14.90	216.10	9.50	137.78
	10	13.82	200.44	8.84	128.21
	25	13.22	191.73	8.46	122.70
	50	12.92	187.38	8.27	119.94
95°C	1	12.70	184.19	8.10	117.48
	5	10.75	155.91	6.88	99.78
		10.15	147.21	6.49	94.12

Table 10.01

$$p = \frac{\sigma}{S \times SF}$$

- p = Admissible work pressure
- σ = Hydrostatic effort at MPa
- S = Pipes series
- SF = Security factor

Working pressure supported by the pipes for pressurised water.

The maximum work pressures according to the resistance equation to the internal pressure in accordance with DIN 8078, bearing in mind a security factor SF.

System description

TECHNICAL CHARACTERISTICS			
PROPERTIES	VALUES	UNITS	STANDARDS
Material	PPR CT RP + FV	-	-
Density	>0.93	g/cm ³	ISO 1183
Melt mass flow rate (230°C/2,16kg)	0.25	g/10'	ISO 1133
Hydrostatic (hoop) stress (20°C-1h) a 15 Mpa	No fault	-	ISO 1167
Hydrostatic (hoop) stress (95°-22h) a 4.2 Mpa	No fault	-	ISO 1167
Hydrostatic (hoop) stress (95°C-165h) a 4.0 Mpa	No fault	-	ISO 1167
Hydrostatic (hoop) stress (95°C-1000h) a 3.8 Mpa	No fault	-	ISO 1167
Thermal stability (110°C-8760 h) a 2.6 Mpa	No fault	-	ISO 1167
Longitudinal retraction (135°C)	<2	%	ISO 2505
Tensile Modulus	>950	Mpa	ISO 527
Tensile strain at yield	>12	%	ISO 527
Ultimate tensile stress	>30	Mpa	ISO 527
Lineal thermal expansion	<0.04	mm/m°C	-
Thermal conductivity coefficient	0.24	W/m °C	DIN 52612
Opacity	SI	-	ISO 7686
Impact resistance determination (ball drop method)	H50≥1m (s3,2) H50≥0.7m (s4 - s5 - s6,3 - s8)	m	EN 1411
Roughness k	0.003	mm	-

Table 10.02

The MecFlow product shall be offered to meet fire classification level B-s1,d0 in accordance with EN13501.

The MecFlow product is a low smoke, zero halogen product with anti-microbial and anti-fouling properties built into the product. The product is disinfection resistant with no degradation of the pipe during the disinfection process.

The MecFlow product is UV stabilised and has a high abrasion resistance ensuring a durable, reliable product during installation.

The MecFlow product range offers comprehensive solutions inclusive of riser pipework, run-out to manifolds, run-out to corridor (with tee connections into separate supply areas), as well as a range of two to twelve-port manifolds (other combinations to be made available upon request).

MecFlow products shall be supplied with minimal packaging. Where items are to be supplied loose (in the case of electrofusion couplings), they are to be supplied in returnable totes, to minimise the quantity of waste on-site. Where possible, pipework systems shall be delivered on returnable stillages.



INSTALLATION

During installation, The MecFlow product can be connected using the CLICKWELD patented technology. The CLICKWELD clips shall allow the pipework to be located into position and rotated to the correct angle of installation (pre-electrofusion).

MecFlow pipework shall be supplied with male/female CLICKWELD couplings with the necessary pipework intersecting branches, being pre-manufactured with a pipe tail offered for connection to a valve set/manifold.

The pipework should be insulated (by others) in accordance with the application of use and specification requirements.

Care should be taken when handling the pipework and connecting the CLICKWELD couplings to ensure all clips are firmly in place and located correctly. The Installation Engineer shall take care to ensure adequate bracketry and fire sleeves are used as per the specification requirements.

TESTING

The MecFlow product will be supplied with pre-tested welds for fabricated sections of pipework. Post-installation testing shall be carried out in-line with the specification requirements to ensure all electrofusion couplings have been fired correctly as per manufacturer guidelines.

FLUSHING

The MecFlow product shall be flushed in accordance with the specification requirements.

11. Support

As the industry moves forward, we're here right by its side. MecFlow, through our Polypipe Advantage service, is proof of our commitment to making things simple for our customers, an innovative plastic water supply system that's designed for the future.

Our website also provides useful information to keep you up to date with news and innovations as they happen, including how MecFlow can further enhance your project, whilst providing a streamlined, cost-effective, labour and time-saving alternative to traditional piping methods.

CLICK. WELD. DONE.

The future of water supply starts here.

To find out more visit polypipe.com/mecflow

Polypipe Building Services

Investing in our business and our people enables us to bring more expertise, more support and more innovation to our customers, helping them to create safe and sustainable commercial buildings, whether newbuild or refurbishment projects.

BUILDING SERVICES SPECIALISM

Having made significant investment in expanding our portfolio to include not only our trusted and well-established Terrain drainage systems, but also MecFlow, our new water supply system, we're committed to working with our customers to provide the best building services solutions for their project. From schools, hospitals and tall buildings to shopping centres, local authorities and commercial and industrial developments, we provide drainage and water supply solutions that help our customers create safe and sustainable services within buildings.

SERVICE AND SUPPORT

Recognising the challenges the construction industry faces, we continuously research and develop products and services that enable us to support our customers more – from working with Engineers to design the best solutions for complex projects to helping Contractors overcome labour shortage issues, a lack of on-site storage and on-site waste management. We develop services to support our customers so that together, we can achieve more.

POLYPIPE ADVANTAGE SERVICE

The Polypipe Advantage service has been specially developed to complement our products and services offering. The Polypipe Advantage team is with you every step of your project, from initial design and project planning, through to manufacture and delivery. By creating fabricated Terrain drainage stacks and MecFlow Kits off-site, we're able to provide our customers quick and more efficient installations on-site. For more information on how the Polypipe Advantage service could benefit your next project, email: mecflow@polypipe.com.

SUPPORTING PRODUCTS AND LITERATURE

With both drainage and water supply systems in its portfolio, Polypipe Building Services has a number of solutions for your next project. More information on these systems can be found at: polypipe.com/commercial-building-services

TAKING YOUR PROJECT FURTHER

As part of the Polypipe Group, we have a number of complementary water and climate management systems available to maximise the comfort and efficiency of your commercial building:

Nuaire Ventilation Systems

Our Nuaire brand has been at the forefront of packaged Air Handling Units (AHUs) for over 20 years, designing and manufacturing market leading ranges. Explore the full range of Nuaire ventilation systems at www.nuaire.co.uk.

Polypipe Underfloor Heating

Underfloor heating systems are increasingly popular and are rapidly becoming the heat source of choice for commercial and multioccupancy residential developments. For more information on our range of Underfloor Heating Systems, controls and manifolds visit: www.polypipeUFH.com.

Polypipe: Inspiring Green Urbanisation

To help address the pressures that urbanisation and climate change place on our built environment, we've developed a new generation of technologies that sustain and optimise urban green assets through extended and fully integrated water management solutions. Systems that make space for water, alleviate flooding and capture, store and reuse rainwater, whilst enabling and inspiring Green Urbanisation. www.polypipe.com/civils/gi



MecFlow
+44 (0)1622 795200



Polypipe Building Services
+44 (0)1622 795200



Polypipe Advantage
+44 (0)1622 795200



Terrain Drainage
+44 (0)1622 795200



The Polypipe Way
+44 (0)1709 770000



Polypipe: Inspiring Green Urbanisation
+44 (0)1509 615100

All descriptions and illustrations in this publication are intended for guidance only and shall not constitute a 'sale by description'. All dimensions given are nominal and Polypipe may modify and change the information, products and specifications from time to time for a variety of reasons, without prior notice. The information in this publication is provided 'as is' on January 2020. Updates will not be issued automatically. This information is not intended to have any legal effect, whether by way of advice, representation or warranty (express or implied). We accept no liability whatsoever (to the extent permitted by law) if you place any reliance on this publication you must do so at your own risk. All rights reserved. Copyright in this publication belongs to Polypipe and all such copyright may not be used, sold, copied or reproduced in whole or part in any manner in any media to any person without prior consent. Polypipe is a registered trademark of Polypipe. All Polypipe products are protected by Design Right under CDPA 1988. Copyright © 2020 Polypipe. All rights reserved.

MecFlow. The future of supply systems

Design, specification
and installation guide



Polypipe Building Services

New Hythe Business Park

College Road

Aylesford

Kent

ME20 7PJ

Tel +44 (0) 1622 795200

Fax +44 (0) 1622 7167965

Email MecFlow@polypipe.com

www.polypipe.com/mecflow